



CATALOGO
2014



CATALOGO **2014**

www.imexares.com.ar | ventas@imexares.com.ar

O-1**FA 12**

50 x 13/20mm

HONDA

CB 750 K1/K2/K6 | 69-77 | F

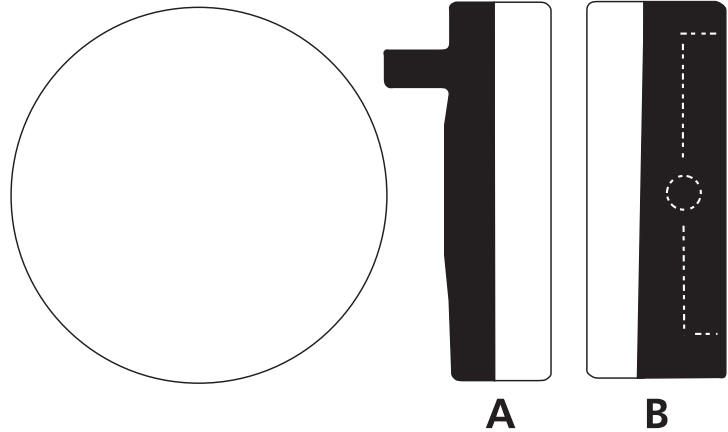
**O-2****FA 13**

52 x 13/20mm

HONDA

CB 250 GS	75	F
CJ 250 T	77	F
CB 360 G5	75	F
CJ 360 T	78	F
CB 400 F/F1/F2	75-79	F
CB 500 T	75-77	F
CB 500 K1/K2/F	75-77	F
CB 550 F/F1/F2/F3	78-80	F
CB 750 F/F1	76-77	F
CB 750 K7	78	F

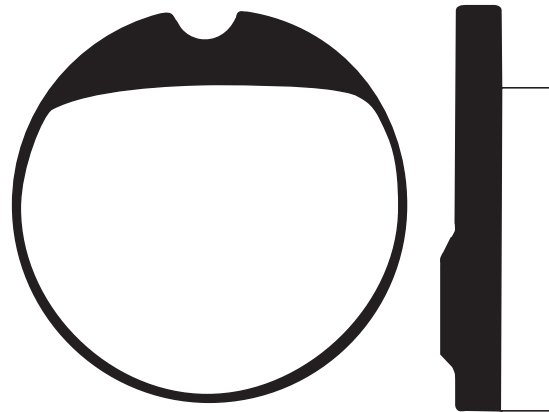
**O-4****FA 11**

48 x 9mm

YAMAHA

RD 250 A/B/C	75-77	F
RD 250 D	77	F & R
RD 350 A/B	74-76	F
XS 360 B	75	F
RD 400 C/D	76-77	F & R
TX/XS 500 B	75-77	F
XS 650	75	F

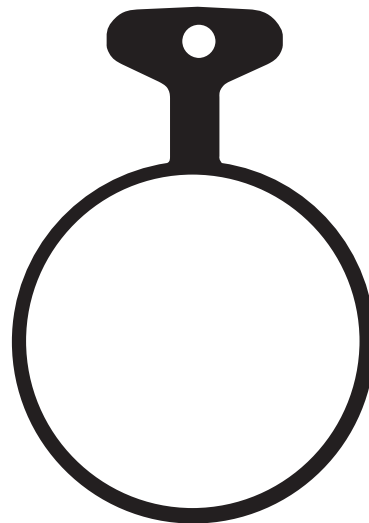

0-5 / 0-30

FA29/30/31

FA29 > HONDA

CX 500	78-79	F
CB 900	80	R
CBX	80	R
GL 1000 K/76/L	75-77	F
GL 1000	80	F
GL 1100/1100	81	R

FA30 > HONDA

CB 750 F	79-80	F & R
CB 900 C	80	F
CBX	80	F
GL 1100/1100	80	F

FA31 > HONDA

CB 750 F	77-78	F & R
CBX	79	F & R

FA 29 > 67x49.2x11mm

FA 30 > 67x49.2x10mm

FA 31 > 67x49.2x9mm

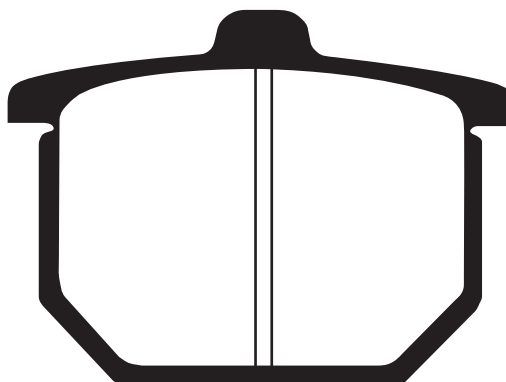

0-6

FA32

57.8x65.3x11mm

HONDA

CB 750 F	75-76	R
GL 1000	75-79	R

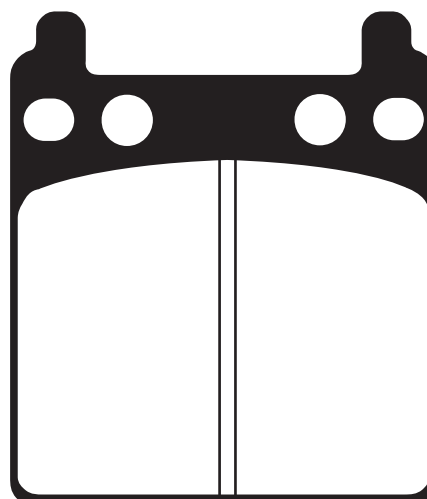

0-7 / 0-132

FA33

A > 51.3x12.3 mm

B > 50x12.5 mm

HONDA

KH 500 A8	76	F
KZ 650 B1/B2/B2A/B3	77-79	F
KZ 650 C1/C2/C3	77-79	F
KZ 650 D1/D1A SR	78-79	F
KZ 750 B1/B2/B3/B4	76-79	F
KZ 900 A4/A5	76-77	F
KZ 900 B1	76	F
KZ 1000 A1/A2/A2A	77-78	F
KZ 1000 B1/B2	77-78	F
KZ 1000 C1/C1A	78	F
KZ 1000 D1	78	F

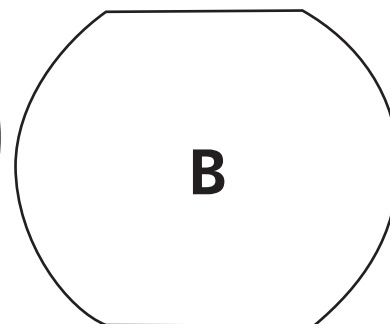
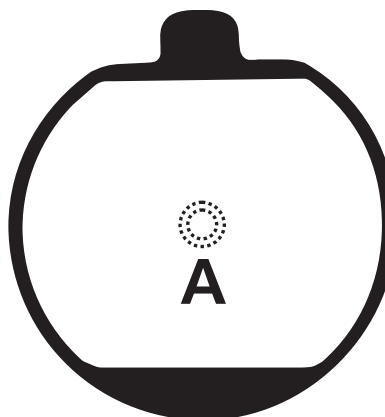

0-8**FA36**

57.6x52.8x9 mm

SUZUKI

GSX 400 FX/FZ/FD	78-79	R
GS 550 EC/EN	78-79	R
GS 550 ET/EX/EZ/LT	80-84	R
XN 85 Turbo	83	R
GS 650 GTX/GTZ/GTD	81-83	R
GS 700 EF/ESF	85	R
GS 750 B/DB/DC/EC/EN	77-80	R
GSX 750 ET/EX/ESD	82-86	R
GSX 750 SE Katana	85	R
GSX 750 S-2/S-2C Katana	84	R
GS 850 GN/GT/GX/GZ	79-85	R
GS 1000 HC/EC/EN/SN	78-80	R
GS 1000 ET/GT/GX	81-82	R
GSX 1000 SZ Katana	82	R
GSX 1100 ET/EX/EZ	80-83	R
GS 1100 GZ	82	R
GV 1200 GLF/GLF2	85-86	R

KAWASAKI

Z 500 B1/B2	79-80	R
Z 650 C3/D2/D3-SR	78-80	R
Z 1000 D1/D3 (Z1R)	78-79	R
Z 1000 A1/A4	77-80	R

KAWASAKI

Z 1000 ST (E1/E2 sahft)	79-82	R
Z 1000 H1	74	R
Z 1300 A1/A5	79-83	R
ZG 1300 A1/A3	84-86	R

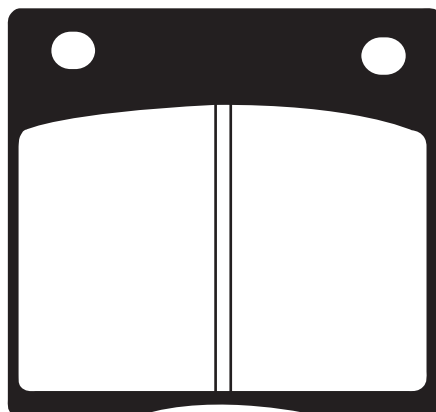
**0-9****FA35****A** > 49.9x11 mm**B** > 50.3x12.5 mm**SUZUKI**

GS 400 B/C/N	77-78	F
GS 425 EC/EN	78-80	F
GS 750 GN	77-80	F

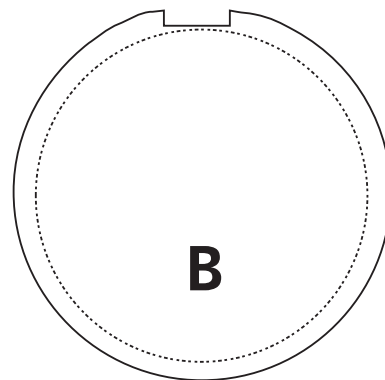
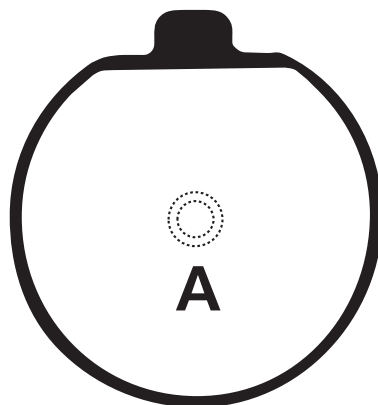
**0-10****FA34**

66x49.4x11 mm

YAMAHA

SR 500 G/H	80-81	F
XS 500 C/D/E	76-78	F & R
XJ 650 RJ	82	F
XS 650 D/E/F/2F	77-79	F
XS 650 SE/SF/SG	78-80	F & R
XS 650 G/H/SH	80-81	F
XS 650 SJ/SK	82-83	F
XS 750 D/2D/E/F	77-79	F & R
XS 750 SE/SF	78-79	R
XS 850 G/H	80-81	F & R
XS 850 LG/LH/SG/SH	80-81	R
XV 920 RH/RJ	81-82	F
XS 1100 E/F/G/H	78-81	F & R
XS 1100 SG/SH	80-81	R

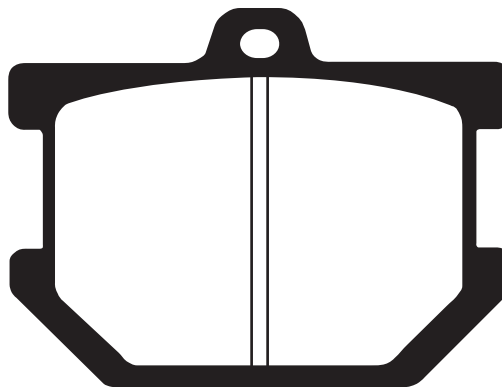

0-12**FA37**

51.5x13/12mm

KAWASAKI

Z 650 C1/C2	76-77	R
Z 750 B1/B2	77-78	R
Z 650 D1	76	R

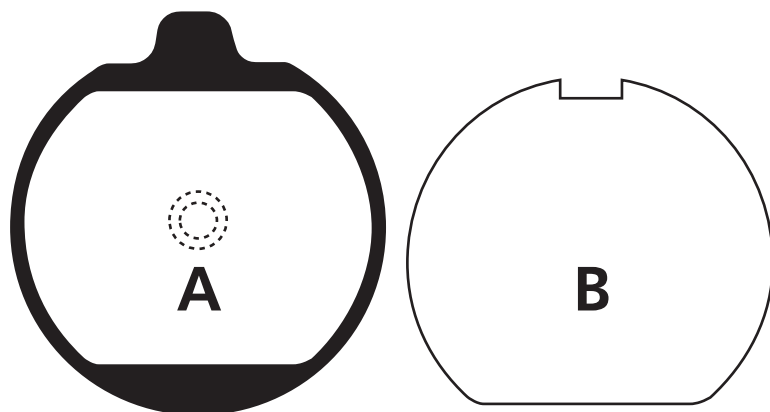
**0-14****FA61**

94 x 56mm (Tapered) 1Left/1Right

YAMAHA

XI 650 G/H/J/K	75	F
XI 650 LH	81	F
XS 750 SE	79-80	F
XV 750 SE	81	F

**0-16**

9mm

YAMAHA

110	81	F
-----	----	---

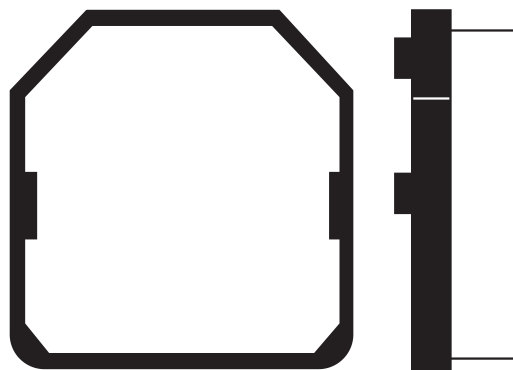

O-17**FA65**

71.6x45.2 x11.5mm

SUZUKI

GS 550 ET/EX/EZ/LT/LX	80-84	F
GR 650 D/XD Temper	83	F
GS 650 GTX/GTZ/GTD	81-83	F
GSX 750 S/SS	84	F
GSX 750 S-2/S-2C	84	F
XN 85 Turbo	83	F
GS 1000 ET	81	F
GSX 1100 SZ Katana	82	F
GSX 1100 ET/EX/EZ	80-83	F
GS 100GZ	82	F
GSX 1100 SZ/SD	82-83	F

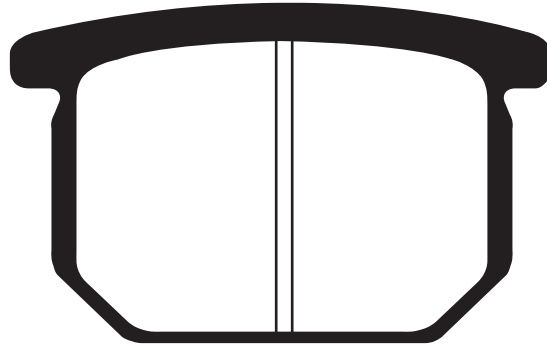
**O-18****FA 68**

67.8x40.7x9.5mm

KAWASAKI

Z 250 A3	81	F
Z 400 J2/J3	81-83	F
Z 440 C2	81	F
Z 440 D5/D6 (LTD)	83-84	F
Z 440 H1/H2	82-83	F
GPZ 550 D1	82	F & R
Z 550 A2/A3/C1/C2	81-84	F
Z 650 F2/F3/F4	80-83	F
Z 700 A1	84	F & R
Z 750 E1	80	F & R
Z 750 H1/H2	80-81	F & R
Z 750 L1/L2/L3/L4	81-84	F & R
Z 750 N1/N2 Spectre	82-83	F & R
GT 750 P1-P9	82-96	F & R
GPZ 750 R1	82	F & R
Z 750 Y1	82	F
Z 1000 J1/J3/K1/LTD	81-83	F & R
Z 1100 A1-A3	81-83	F & R
GPZ 1100 B1/B2	82-83	F & R
Z 1100 D1/D2 Spectre	82-83	F & R
Z 1100 R1 Lawson	84	R

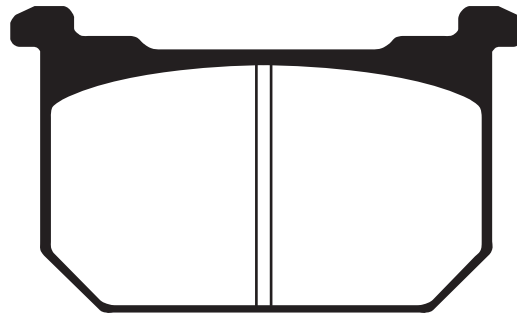
**O-19/O-130****FA69**

90x49x10 mm

HONDA

CN 250 Helix	86-87	F
CB 450 SC	83-86	F
CMX 450 C Rebel	86-87	F
GB 500	89-90	F
GL 500 Silverwing	81-82	F
VT 500 C Shadow	83-86	F
VT 500 FT Ascot	83-84	F
VF 500 C V30 Magna	84-85	F
VF 500 F Interceptor	84-86	F & R
CB 550 SC Nighthawk	83	F
CB 650	82	F
CB 650 SC Nighthawk	83-85	F

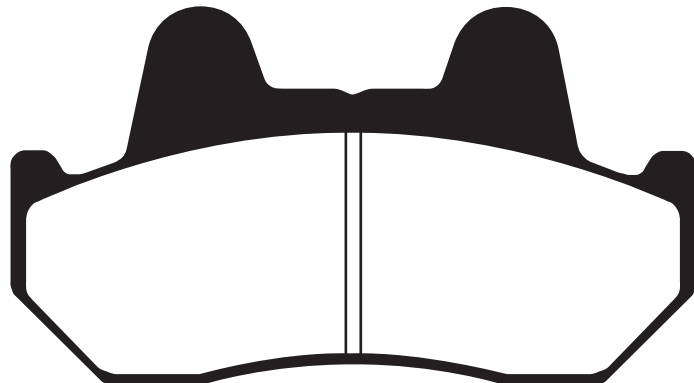
Continúa en página siguiente.

O-19/O-130 CONT.

FA69

90x49x10 mm

HONDA

CB 650 Custom	83	F
CX 650 T Turbo	83	F&R
GL 650 Silverwing	83	F
CB 700 SC/S	84-86	F
GS 650 GTX/GTZ/GTD	81-83	F
VF700 C Magna	84	F
VF 700 F Interceptor	84-85	F
VF 700 S Sabre	84-85	F
VT 700 C Shadow	86-87	F
CB 750 F Supersport	81-82	R
CB 750 SC Nighthawk	82-83	F
VF 750 C V45 Magna	82-83	F
VF 750 S Sabre	82-83	F
VT 800 C Shadow	88	F
CB 900 C Custom	82	R
CB 900 F Supersport	81-82	R
CBX	81-82	R
CB 1000 C Custom	83	F&R

VF 1000 F Interceptor	84	F
VF 1000 R	85-86	F
CB 1100 F Supersport	83	F&R
GL 1100/1100	82	R
XL 600 V Transalp	89-90	F
CN 250 Helix	92-93	F
CM 400 C Custom	81	R
CM 450 C Custom	82	F
CM 450 A	82	F
GL 500	81-82	F
CB 750 C Custom	82	F
CBR 600 F Hurricane	87-90	R
VF 700 F Interceptor	84-85	R
VF 700 C Magna	87	F

O-20

FA45

54x53x11 mm

HONDA

CB 250 T/N/NA/NB/NDB	78-82	F
CB 250 RSA/RSD	81-84	F
CM 250 TB	81	F
CB 400 A "Honda-matic"	79	F
CB 400 T	78	F
CB 650 Z/B	79-81	F
CB 750 KZ	80	F

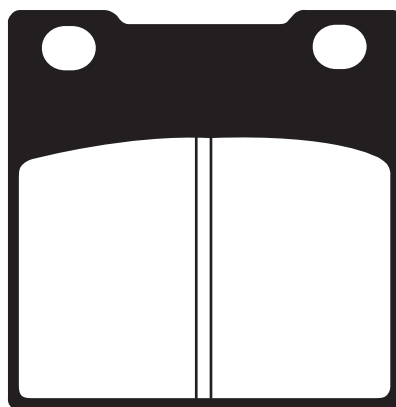

O-21

FA51

78x50x11.5 mm

SUZUKI

GN 250 F/J/M/R/T	87-97	F
GS 250 TT/TX	80-81	F
GSX 250 ET/EX/EZ	80-82	F
GN 400 TT	80	F
GSX 400 ET/EX/EZ	81-83	F
GSX 400 LX/TX	81	F
GS 450 ET/EG/EJ	80-88	F
GS 700 EF/ESF	82-86	F
GSX 750 ESD/EFE/ESG	82-86	F
GSX 750 ET/EX	80-81	F
GS 850 GZ/GE/GG	82-85	F
GS 1000 GT/GX	81-82	F
GV 1200 GLF/GLF2/GLGI	85-86	F



O-22

46x44x16/11mm

KAWASAKI

400 c.c.

78-81

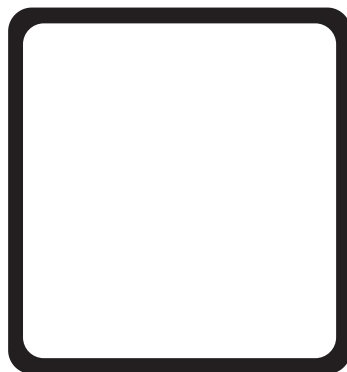

O-23

A > 45 x 8.5 mm

B > 44 x 10 mm

SUZUKI

125

80-81

GILERA

Sahel 200

MOTOMEL

Dakar 200

Skua200

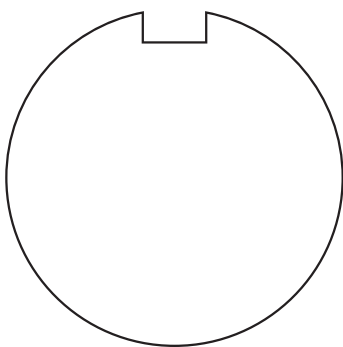

A

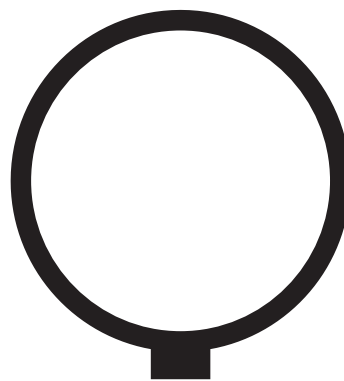

B



O-24

FA38

A > 50 x 12 mm

B > 50 x 11.9 mm

SUZUKI

GT 125 C/EC/EN | 80-82 | F

GT 200 EN/EX "X5" | 79-82 | F

GT 250 EN/ET/EX "X7" | 78-81 | F

GS 550 DB/DC/EC/EN | 77-79 | F

GS 850 GN/GT/GX | 79-81 | F

GS 1000 HC/EC/EN/SN | 78-80 | F

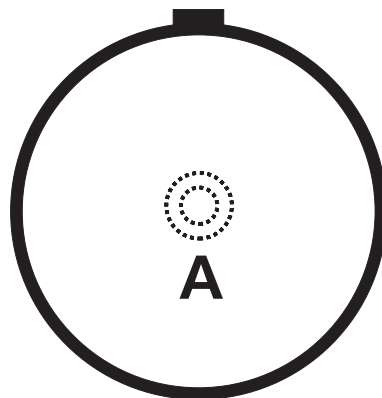

A

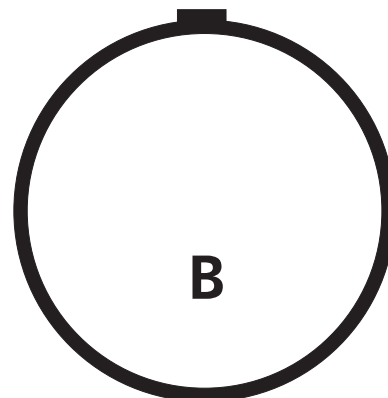

B

O-27**FA40****A** > 41 x 21 mm**B** > 41 x 11 mm**HONDA**

CB 50 J	81	F
SS 50 ZB2	77-80	F
CB 125 J/T	78-79	F

POLARIS

Trail Boss 2 x 4	85-87	R
Scrambler 3 wheeler	85-86	R & R
Cyclone "250 X"	87	R

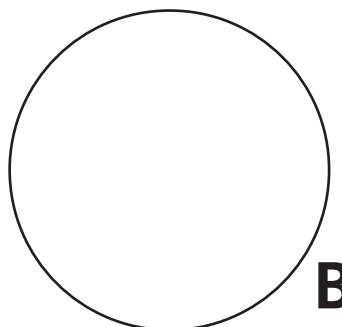
**O-28****FA18**

55.7 x 55 x 9 mm

BMW

R 65	07/88-08/89	F
R 65 GS	87-92	F
R 65 RT	85-88	F
R 80 RT	82-84	F
R 80 / R 80 RT	84-08/88	F
R 80 GS	80-87	F
R 80 ST	82-84	F
R 80 TIC	09/80-85	F
R 100/7T	09/80-84	F
R 100 S	09/80-80	F & R
R 100 RS	10/80-84	F & R
R 100 RT	87-08/88	F
R 1100 RS	92-01	R
K 75/75-2	84-07/90	F
K 75 C	85-08/88	F
K 75 RT	89-96	R
K 75 S	85-09/88	F & R
K 100	82-09/88	F & R
K 100/ S	87-08/88	F & R
K 100 LT	86-08/88	F & R
K 100 RS/RT	83-09/88	F & R
K 100 RS	89-92	R
K 1	88-93	R
K 1100 LT	89-99	R
K 1100 RS	92-96	R
K 1200 RS	96-03	R
K 1200 GT	03	R

DUCATI

751 F1	86	F & R
750 Paso	87-90	F
750 Sport	88-90	F & R
906 Paso	88-89	F & R

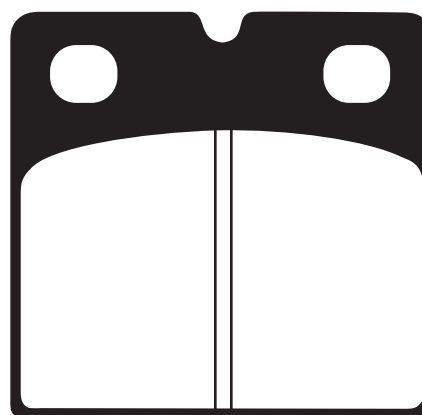
**MOTO GUZZI**

California 1000 II/III	83-93	F & R
1000 SP II/III	83-94	F & R
1000 GT	87-91	F & R
1000 Le-Mans	84-93	F & R
Strada 1000	93-94	F & R
California 1100	94-97	F & R

APRILIA

RS 250 (All models) | 99-03 | R

CAGIVA

Mito 125 | 92-92 | R

DUCATI

Supersport 400 | 93-97 | R

400 Monster | 00-01 | R

400 Monster | 95-97 | R

600 Monster | 93-01 | R

600 Monster Dark | 98-99 | R

600 Monster City | 99 | R

600 Supersport | 91-97 | R

620 IE Monster | 02-03 | R

620 Sport | 03 | R

748 Racing | 99 | R

748 SPS | 99 | R

748 R/RS/S | 00 | R

748 R | 01 | R

748 RS | 01 | R

748 S | 01-02 | R

748 Testa Bassa | 01 | R

748 E | 02 | R

750 Supersport | 91-98 | R

750 Monster | 96-98 | R

Monster 800 IE/SIE | 03 | R

888 SP4/SP5 | 92-93 | R

888 Superbike Stradal | 94-95 | R

900 Supersport | 91-97 | R

900 Monster | 93-99 | R

900 Monster Cromo | 98 | R

900 Monster City | 99 | R

900 IE Monster | 00-01 | R

916 Bipoastro-Sennal | 94-98 | R

916 SPS | 98 | R

Monster S4 | 01-03 | R

996 | 98 | R

996 SPS/SPS II | 99 | R

996 | 00 | R

996 S | 01 | R

998 | 02-03 | R

998 "S" | 02 | R

Monster 1000 IE/SIE | 03 | R

HUSQVARNA

125/250/500 XC | 85 | F

125/250/500 CR | 85 | F

MALAGUTI

Most 1985 Models | F

Most 1986 Models | F & R

MZ

Skorpion Tour/Traveller | 95-02 | R

FA47> 40x58x7mm

FA 47-2> 40x58x5.5mm

FA47-3> 40x58x9.3mm

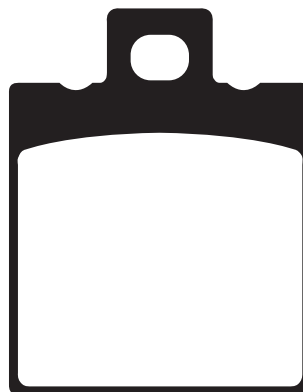

MOTO GUZZI

V 35 Florida (350) | 86-90 | F & R

NTX 350 | 87-90 | F & R

350 Nevada | 92-97 | F & R

350 Nevada Club | 98-99 | F & R

V 50 C (500) | 82-86 | F & R

NTX 650 | 87-90 | F & R

V 75 (750) | 92-96 | F & R

750 SP | 90-92 | F & R

750 Targa | 90-92 | F & R

Nevada 750 | 91-97 | F & R

Daytona 1000 | 92-95 | R

V 10 Centauro | 97-99 | R

Sport 1100 | 94-99 | R

Sport Corsa 1100 | 98-99 | R

V11 Sport/Scursa/Naked | 99-03 | R

V 11 Le Mans | 01-03 | R

LAVERDA

650 Sport | 94-95 | R

668 Diamante | 96-98 | R

750 Strike Bifaro | 98-00 | R

750 S Formula Sport | 98-00 | R

750 S Carenta | 98-00 | R

ATK

All Models | 92 | R

FA67 > 55.5 x 58 x 7mm

FA 67-2 > 40 x 58 x 5.5mm

FA67-3 > 40 x 58 x 9.3mm

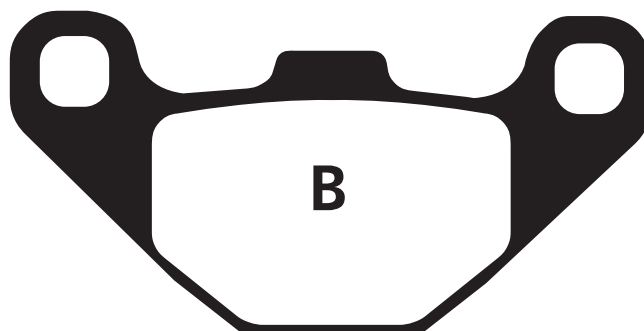
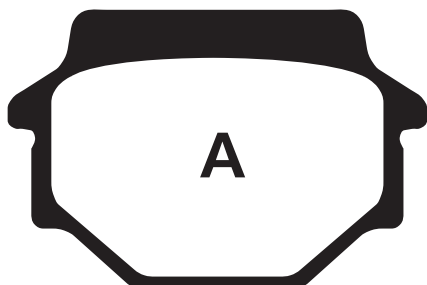

CAGIVA

WMX 125/250	89	R
-------------	----	---

HUSABERG

All Models	92-94	R
499 MX	92-93	R

HUSQVARNA

All Models	90-91	R
------------	-------	---

KTM

125/250/350/500 MX	89-91	F&R
125/250/350/500 MX	92-93	R
125/250/300/600	92-93	R
250/300 E/XC/GS	90-91	R
EXC/020/EGS/620 SX	94-95	R

KAWASAKI

KX 125 B2/C1/D1	83-85	F
KX 125 E1	86	F&R
KX 125 E2/F2	87-88	R
KMX 200 A2/A3	88-92	R
KDX 200 C1-C3/E1-E4	86-92	F
KX 250 C1/C2/D1	83-85	F
KX 250 D2	86	F&R
KX 250 E1/F1	87-88	R
KLR 250 D2-D16	84-00	F
KLR 250 H1	98	R
KX 500 A1/A2/B1	83-85	F
KX 500 B2	86	F&R
KX 500 C1/D1	87-88	R
KLR 600 A1/A2/B1-B4	84-88	F
KL 650 B1-B3 Tengai	89-92	R
KLR 650 C1-C8	95-04	R

MAICO

500 MX	94-98	R
--------	-------	---

SUZUKI

RB 50 H GSXR 50	87	F
RG 50 EW	--	F
OR 50 ET	80	F
ZR 50 SLKX	81	F

FA67/2 - FANTIC

50 Strada	82	R
50/50 1 Raider	81	R

HERCULES (SACHS)

50 Supre 4 GP	--	F
---------------	----	---

MALAGUTI

50 MDX Gold Enduro	87	F
50 Enduro MEX	87	F
50 Enduro MSX	85	F

FA67/3 - KAWASAKI

ZZR 250 (Ex 250 H1-H13)	90-03	R
ZXR 250 C1-C3	91-93	R
ZXR 250 R/SP/D1	91	R
ZR 250 A1/A5	91-95	R
ZR 400 D1/D3/D4	92-95	R
GPZ 500 S	94-01	R
KLE 500 A1-A12	91-04	R
KLR 650 A1-A3	87-89	R

KRAM-IT (KRAMER)

ER 125/250/300 RV3	88	R
ER 500/600	96	R

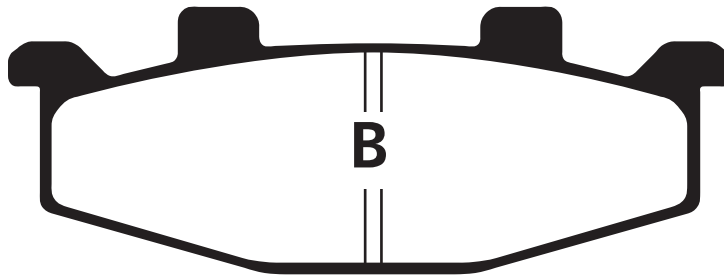
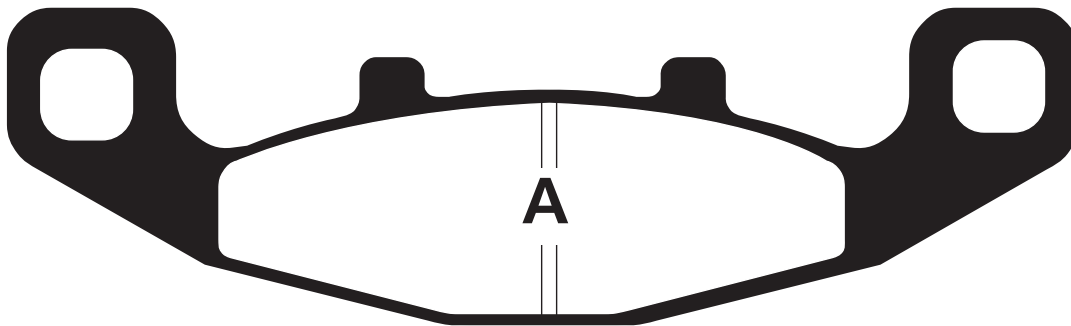
O-33**FA 129****A** > 141 x 41.5 x 9.7 mm**B** > 95 x 34.5 x 9.7 mm**KAWASAKI**

GPX 250 R (ZX 250)	88-95	F
GPX 250 R (EX 250)	87	F
KLE 250 A1/A1A/A2		F
ZZR 250	90-03	F
ZR 250 A1-A5	91-95	F
GPX 400 R	87	R
GPZ 400 R "D4"	88	R
ZRX 400	94-95	F
ZZR 400	90-92	E
ER-5	97-00	F
GPZ 500 S	87-01	F
KLE 500 A1-A12	91-04	F
ZR 550 B2-B6	91-99	F
GPX 600 R	88-96	F & R
ZL 600 B1	95-97	F
ZZ-R 600	90-93	R
KL 650 B1-B3	89-92	F
GPX 750 R	87-89	F & R
ZR 750 C1-C5	92-95	F & R
ZR 750 D1	96	R
GPZ 900 R A7-A8	90-96	R
GPZ 900 R	98	R
ZX 100 B1-B3	88-90	F & R
1000 GTR	94-98	R
ZG 1000 A9-A18	94-03	F
ZZR 1100	90-92	R
ZR 1100 A1-A4	92-95	R
ZR 1100 B1	96-97	R
ZR 1100 B5	02	F

HYOSUNG

Comet 250/600	02	F
---------------	----	---

SUZUKI

RG 125 UN "Wolf"	92-94	F
GSF 250 N/ZM/P7NP	92-96	F
GSX 250 SSM Katana	91	F
SW-1 250	92	F
GSF 400 M/N/P Bandit	91-95	F
GS 500 EK/EL/EM/EN	89-95	F
DR 800 SM	91	F
VX 800 L/M/N/P/R	90-96	F
GSX 1100 GM/GN	91-94	F

0-34**FA131**

75x36x10.5mm

HONDA

CR 80 R/RB Expert	92-02	R
CR 85 R	03	R
CR 125 R	87-01	R
CR 250 R	87-01	R
XR 250 R	90-03	R
XR 250 L	91-96	R
XR 400 R	96-03	R
CR 500 R	87-01	R
XR 600 R	91-00	R
XR 650 L	93-03	R
Falcon 400		R

KAWASAKI

KX 125 K2/K3/K4	95-03	R
KX 250 K2/K3/K4	95-03	R
KLX 300 R A2/A3/A4	97-03	R
KLX 400 SR	03	R
KX 500 E8/E9/E10	96-03	R
KLX 650 R D1	96	R

SUZUKI

RM 125 T/V/W/X	96-03	R
RMX 250 X/Y	96-03	R
DR-Z 400 SY/SK1	00-03	R

YAMAHA

YZ 125 K/L/M/N/P	98-02	R
WR 250 FN/FP	01-02	R
YZ 250 K/L/M/N/P	98-02	R
WR 400 FL/FM	99-00	R
YZ 400 FL	99	R
YZ 426 FM/FN/FP	00-02	R
WR 426 FN/FP	01-02	R

T.M.

MX Models 125/250	02-03	R
Enduro 125/250/300	02-03	R
Enduro 250/400 E	02-03	R

**0-35****FA140**

86x40x10.2mm

HONDA

CB-1	89-90	R
NT 650 Hawk GT	89-91	R

SUZUKI

DL 1000 K2/K3	02-03	R
---------------	-------	---

BUELL

M2 Cyclone	98-02	R
XB9R	02-03	R
XB9S	03	R
Blast	00-02	R

TRIUMPH

Daytona 600	03	R
Daytona 955i	01-03	R
TT 600	00-03	R
Speed Four	02-03	R



O-36

FA 142 / 196

FA 142 > HONDA

CN 250 Helix	94-01	F
VFR 750 F	90-97	F
CB-1	89-90	F
NT 650 Hawk GT	88-91	F
PC 800 Pacific Coast	89-90	F
CBR 1000 F	90-91	F
ST 1100	91-02	F
ST 1100 A	95	F
GL 1500 C/CT/CF	97-03	F

FA 196 > TRIUMPH

Adventurer	96-01	F & R
Bonneville America	02-03	F & R
Legend TT	98-01	F & R
Thunderbird	95-03	F & R
Tiger 900	92-98	F & R
Thruxton 900	04	F

FA 142 > 101 x 35 x 9mm

FA 196 > 102 x 38 x 9.8mm

FA 142 > SUZUKI

RF 600 RR/RS/RT/RV	94-97	F
GSF 600 Bandit ST	96-98	F
AN 650 K3	03	F

FA 196 > HONDA

CB 250 N/T/W/X	92-03	F
CN 250 3	03	F
VT 250 Spada	89	F
VTR 250 W/Y	98-99	F
CB 400 SS	01	F
FJS 400 S	01-02	F
NV 400 DCY/DC1	00-02	R
VRX 400 T	96	F
CB 500 R/T	94-96	F

FA 196 > YAMAHA

YP 125 Majesty DX	02	F
-------------------	----	---



O-37

FA 130

A > 73.3 x 49.3 x 7mm

B > 60.8 x 62.8 x 9mm

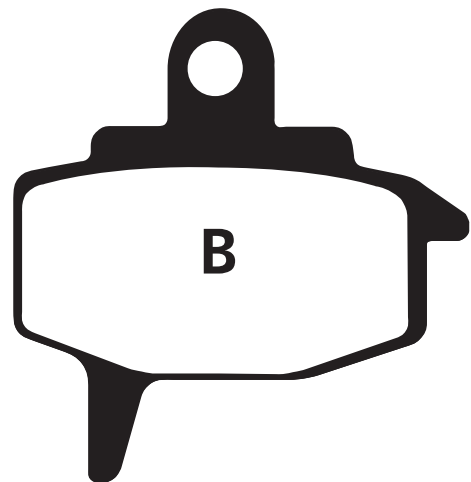
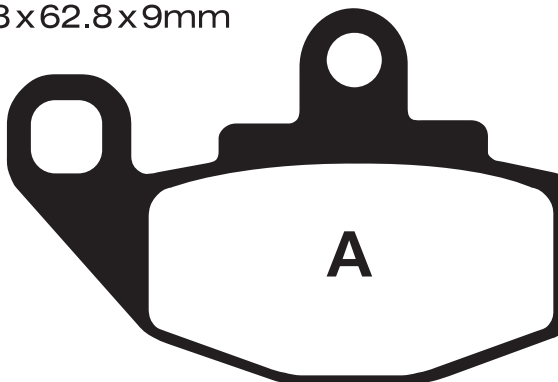

KAWASAKI

CB 250 GS	75	F
CJ 250 T	77	F
CB 360 G5	75	F
CJ 360 T	78	F

0-38**FA160**

57.6x52.8x9mm

MZ

850 KBT | 95 | F

YAMAHA

FZR 600 | 90-93 | F

FZR 600 R | 94-95 | F

TDM 850 | 96-01 | F

FZR 1000 EX UP | 89-90 | F

V-MAX 12 | 93-03 | F

FJ 1200 A (ABS Models) | 90-91 | F

Diámetro de los agujeros 5 mm

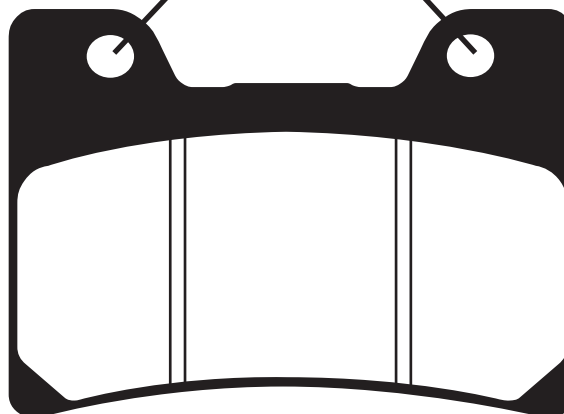
**0-39****FA88**

64x55x9mm

YAMAHA

RZ 350 L/N/NC11 | 84-85 | R

FZR 400 U/SUC/W/SWC | 88-89 | F

XJ 400 S Seca II | 93 | R

RZ 500 | 84-86 | F

FZ 600 S/SC/T/TC/U/UC | 86-88 | F

YX 600 S/SC/T/U/W | 86-90 | F

FZR 600 AC/RAC/RA | 90-00 | R

YZF 600 RG/RGC/RH | 95-96 | R

FZ 700 T/TC Genesis | 87 | F & R

FZ 750 N/S/SC/U/UC | 85-88 | F & R

TDM 850 D/DC/E/EC | 92-93 | F & R

FZR 1000 Genesis | 87-88 | R

GTS 1000 AE/AEC | 93-96 | R

YZF 1000 R | 97-99 | R

XV 1100 All Models | 86-97 | F

FJ 1200 S/SC/CT/TC | 86-87 | F & R

V-Max VMX 12 | 85-92 | F & R

XVS 1100 V Star | 99-03 | R

VMX 12 E/EC/F/FC/G | 93-03 | R

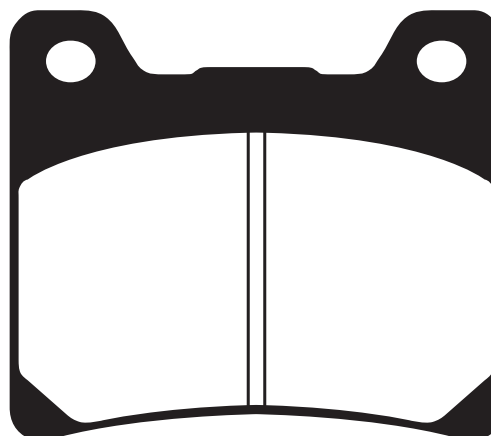
**0-40****FA101**

71x36x9.2mm

GILERA

125 Aproche | 91 | R

RC 600 | 89-90 | R

YAMAHA

TZR 50 Thunserkid | 97-00 | R

YSR 50 T | 87 | F

DT 125 LC | 86-87 | F

TDR 125 R | 93-03 | R

YZ 125 U | 88 | R

XC 125 TR | 96 | F

DT 200 (2LR) | 87 | F

XT 225 Serrow | | F & R

YZ 250 U | 88 | R

XT 350 | 85-95 | F

XT 600 | 87 | R

YBR 125 (China) | |

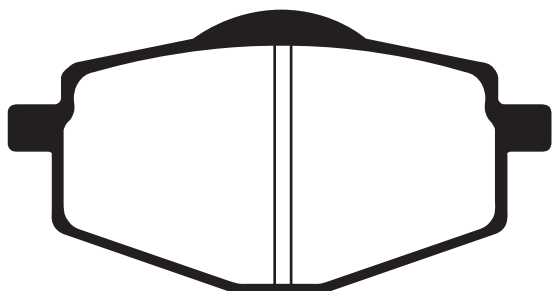

O-41**FA141****A** > 49.9x11 mm**B** > 50.3x12.5 mm**YAMAHA**

XR-1	89	F & R
GPX 250 R	88-95	R
ZR 400 D1/D3/D4	92-95	F

SUZUKI

RGV 250 M/N/P/R/S/T	91-96	R
RGV 250 T	96	R

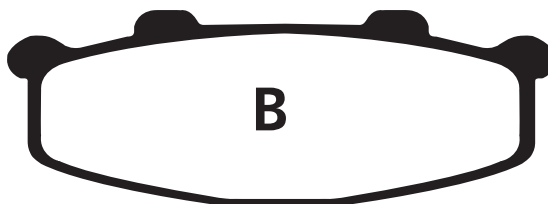
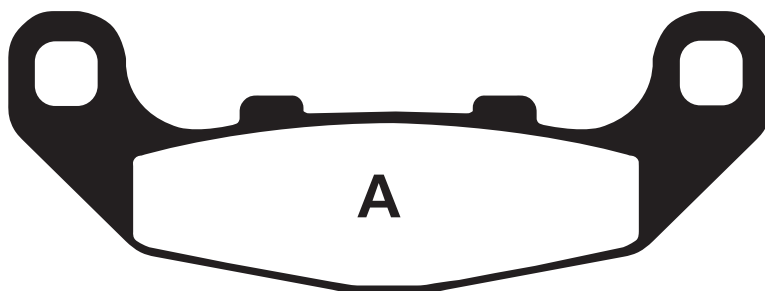
**O-42****FA85****A** > 111x50x9.5mm**B** > 69x43.5x9.8mm**YAMAHA**

EX 250 E1/E2 Ninja	86-87	F & R
EL 250 B2/B3	88-89	F
EN 450 A1/A2/A3/A4	85-90	F
EN 500 A1/A2/A3/A4	90-95	F
EN 500 C1-C8 Vulcan	96-03	F
VN 750 A2-A19	86-03	F
ZX 750 A1/A2/A2L	83-85	F & R
ZX 750 E1/E2 Turbo	84-85	F & R
VN 800 A1-A9	95-03	F
ZX 900 A1/A2/A3	84-86	F & R
ZG 1000 A1/A2/A3	86-93	F & R
ZG 1000 A9-A18	94-03	R
ZL 1000 A1	87	F & R
ZX 1000 A1/A2	86-87	F & R
ZN 1100 B1/B2 (LTD)	84-85	F & R
ZX 1100 A1/A2 (GPZ)	83-84	F & R
ZG 1200 A1/A2/B1-B4	86-03	F & R
ZN 1300 A1/A2/A3	83-88	F & R
VN 1500 A1-A12	87-98	F & R
VN 1500 B1/B2/B3	87-97	F & R
VN 1500 D1/D2/E1/E2	96-97	R
VN 1500 G1/G1A/G2A	99-00	R

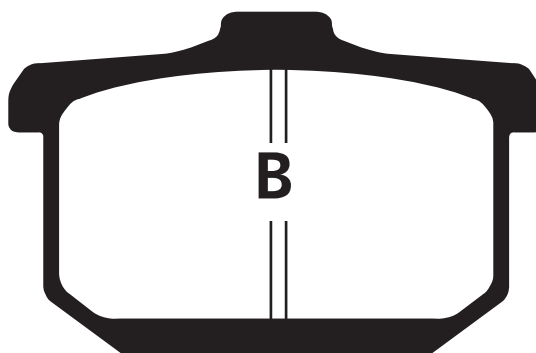
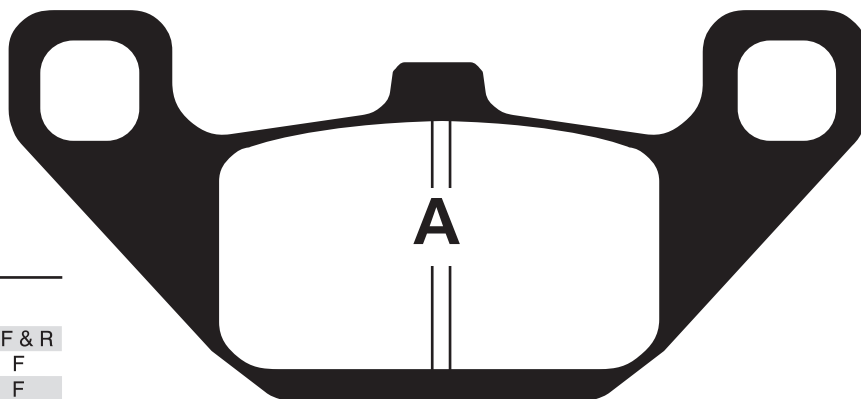

O-43**FA 169**

61 x 27.1 x 7.3mm

YAMAHA

CY 50 RS Jog R	96	F
YW 100 T Booster BWs	96	F
YW 50 AP/AR Zuma	02-03	F

**O-44****FA54 / 178****FA54** > 39.5 x 45 x 7.5mm**FA178** > 41.1 x 43 x 7.7mm**HONDA**

ATC 250 R	81-82	F
CG 125		
CG 150		

GILERA

125

HUSQVARNA

All Models | 92-94 | R

KAWASAKI

KVF 300 A1-A4/B1-B4	99-02	F
KVF 360 A1/B1/C1	03	F
KVF 400 C1-C4/D1-D4	99-02	F
KX 65 A1/A2/A3/A4	00-03	R

YAMAHA

YFS 200 R Blaster	03	F
YFM 350 XW/XA/XB/XD	89-03	F
YFZ 350 A/B/D/E/F/G/H	90-03	F
YFM 350 FXG/FXH/FXJ	95-03	F
YFM 350 FWBL/LC	99	F
YFM 350 UL/ULCV	99	F
YFM 400 FWBM	00-01	F
YFM 400 AM/AN	00-01	F
YFM 400 FPR (4x4)	03	F
YFM 400 FAR	03	F
YFM 450 Fair Kodiak	03	F

MOTOMEL

VX 150

SUZUKI

M 65 K3	03	R
DR 125 G/H/J/SER/SES/SETI	86-96	F
DR 200 G/H/J/SET/SEV	86-88	F
DR 250 F	85	F
LT-F 250 FK2 Ozark	02	F
LT-Z 250 K4 QuadSport	04	F
LT-A 400 K2/K3 Eiger	02-03	F
LT-F 500 FK3 Vinson Q.	03	F

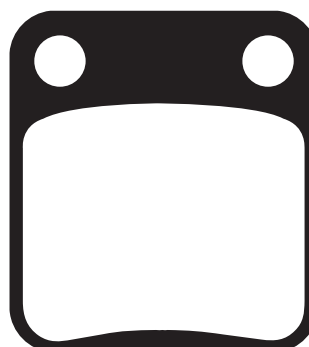
**FA54****FA178**

O-45

51.5x36.5x8.5mm

HONDA

Scooter Lead 50/90
Spaced 50

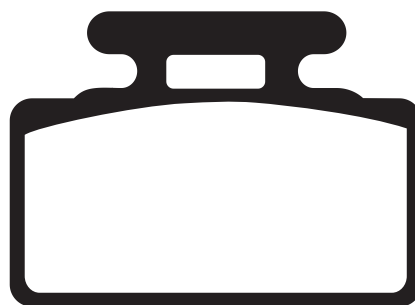

O-46

48x36x8.7mm

HONDA

Scooter Lead 50

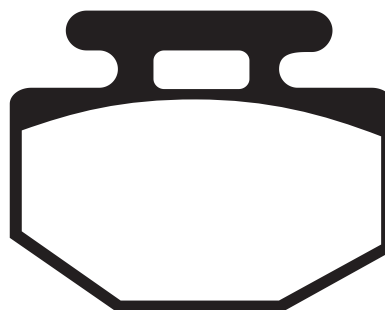

O-47/O-140

FA 143/185

FA 143 > HONDA

NSR 250 RR/R2R	94	R
RVF 400 RR/RR-II/RT	94-96	R
VFR 400 RK/R3L/R3M	89-92	R
VFR 750 RJ/RK/RL	88-90	R
RVF 750 RR/RS "RC45"	94-98	R

FA 185 > HONDA

CR 125 R	95-00	F
CRF 150 F	03	F
CRF 230 F	03	F
NX 250	88-90	F
XR 250 L	93-96	F
XR 650 R	00-02	F
CR 125/250 R	95-03	F
XR 250 R	96-03	F
XR 400 R	96-03	F
CRF 450 R	02-03	F
CR 500 R	95-01	F
XR 600 R	93-00	F
XR 650 L	93-03	F

FA 143 > 94.2x32x10mm

FA 185 > 94x34.2x7mm

1 Izquierdo / 1 Derecho

FA 143

1 Izquierdo / 1 Derecho

FA 185

Continúa en página siguiente.

O-47/O-140 CONT.

FA 143/185

FA 185 > HONDA

XR 650 R	00-02	F
CR 125/250 R	95-03	F
XR 250 R	96-03	F
XR 400 R	96-03	F
CRF 450 R	02-03	F
CR 500 R	95-01	F
XR 600 R	93-00	F
XR 650 L	93-03	F

FA 185 > KAWASAKI

KX 125 K1/K2/K3	94-03	F
KDX 200 H17H2/H3	95-03	F
KDX 220 R A4/A5	97-03	F
KX 250 K1/K2	94-03	F
KLX 250 R D2/D3/D4	94-96	F
KLX 300 R A2/A3/A4	97-03	F
KLX 400 SR	03	F
KLX 400 R	03	F
KX 500 E6/E7/E8/E9	94-03	F
KLX 650 R A1/A2/A3	93-96	F

FA 185 > YAMAHA

YZ 125 K/L/M/N/P/R	98-03	F
WR 250 FN/FP/FR	01-03	F
YZ 250 K/L/M/N/P/FP	98-03	F
WR 400 FK/FL/FM	98-00	F
YZ 400 FK/FL	98-99	F
YZ 426 FM/FN/FP	00-02	F
WR 426 FN/FP	01-02	F
YZ 450 FR	03	F

FA 143 > 94.2 x 32 x 10mm

FA 185 > 94 x 34.2 x 7mm

FA 185 > SUZUKI

RM 125 T/V/W/X/Y	96-03	F
DR-Z 250 K1/K2/K3	01-03	F
RM 250 T/V/W/X/Y	96-03	F
RMX 250 T/V/W/X	96-00	F
DR 350 V/W/X	97-99	F
DR 350 SEW/SEX	98-99	F
DR-Z 400 SY/SK1/SK	00-02	F
DR-Z 400 EY/EK1	00-02	R
DR 650 SET/SEV/SEW	96-01	F

O-48

FA 145

70x55.5x8mm

SUZUKI

GSXR 400 RL/RM/RN	90-95	F
GSXR 750 RG	86	F
RF 900 RR/RS/RS2/RT	94-98	F
GSXR 1100 K/L/M/N	89-92	F
GSF 1200 T/ST/V/SV	96-00	F

YAMAHA

TZ 125	94	F
TZ 250	89	F
FZR 750 R "OWOI"	89-90	F

MZ/MUZ

1000 S	03-04	F
--------	-------	---

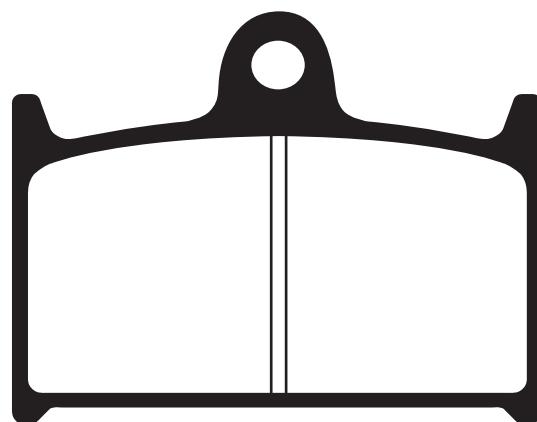

0-49**FA83****A** > 47.4 x 37 x 9mm**B** > 85 x 42.5 x 7mm**KAWASAKI**

AR 50 A1	82	F
AR 80 A1	82	F
KX 80 E2/E3	84-85	F
KX 80 G1/G2	86-87	F
KX 80 J2/L1-L3/N1-N3	96-00	F
KD 80 N1/N2/N3	88-90	F
KX 100 B5/B6	95-96	F
KX 125 B1/250 B1	82	F
KXT 250 A1 Tecate	84	R

SUZUKI

RM 80 G/H/J/K	86-89	F
RM 80 L/M/N/P/R/S	90-95	F & R
RM 80 T/V/W/X/Y	96-00	R
RM 85 K2/K3/LK3	02-03	R

MZ

Moskito/SX 50/RX 50		F
Moskito 125 R		F

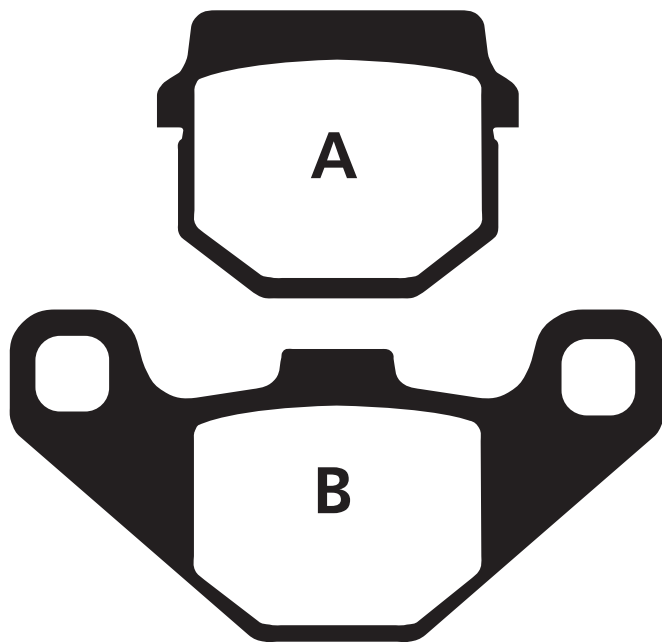
**0-50****FA152**

62 x 40.8 x 9mm

KAWASAKI

KX 125 G1/H1/H2	89-94	R
KDX 125 A1/A2/B1/B2	90-94	R
KDX 200 E1-E6	89-94	R
KDX 200 H1-H5	95-99	R
KDX 200 SR	97-04	R
KDX 220 R A4/A5/A6	97-03	R
KLX 250 RD2/D3/D4	94-96	R
KX 250 G1/H1/H2	89-94	R
KLX 250 F1-F4	94-97	R
KX 500 E1-E7	89-95	R
KLX 650 A1-A3	93-96	R

YAMAHA

TS 125 RK/RL/RM	90-96	R
TS 200 RK/RL/RM	89-94	R
TS 125 RK/RL/RM	90-96	R
TS 200 RK/RL/RM	89-94	R
RM 125 K/L	89-90	R
RMX 250 K/L/M/N/P	89-98	R
DR 250 L/M/N/P/R/S	90-95	R
RM 250 K/L	89-90	R
DR 350 L/M/N/P/R	90-99	R
DR 650 SET/SEV	96-02	R
RM 125 M/N/P/R/S	91-95	R
RMX 125 250 R/S	94-95	R
DR-Z 250 K1/K2/K3	01-03	R
DR 650 SET/SEV	96-02	R
RM 125 M/N/P/R/S	91-95	R
RMX 125 250 R/S	94-95	R
DR-Z 250 K1/K2/K3	01-03	R
XTZ 125/250		R
YBR 250		R

**SUZUKI**

TS 125 RK/RL/RM	90-96	R
TS 200 RK/RL/RM	89-94	R
RM 125 K/L	89-90	R
RMX 250 K/L/M/N/P	89-98	R
DR 250 L/M/N/P/R/S	90-95	R
RM 250 K/L	89-90	R
DR 350 L/M/N/P/R	90-99	R
DR 650 SET/SEV	96-02	R
RM 125 M/N/P/R/S	91-95	R
RMX 125 250 R/S	94-95	R
DR-Z 250 K1/K2/K3	01-03	R

0-51

FA124/124-2

SUZUKI

AN 650 K3/K4/AK4 | 02-04 | R

FA124-2 HONDA

CD 250 UJ	88-92	F
GB 250 J/L/P/S/V	89-97	F
VTZ 250 H/J/K	86-88	F
NV 400 CJ/CK	92-93	F
NX 500 J/K/L/M/N	92-96	F
XL 600 VM/VN/VP	91-93	F
VT 600 C/N	93	F
NX 650 J/K/L/M/N	88-96	F
XRV 650 J	88-89	F
GL 1500 J/K/SEM	88-00	F

FA124-2 CAGIVA

Canyon 500	96-00	F
Canyon 600	96-99	F
E 750 Elefant	93-95	F
E 900 Elefant	90-92	F

FA124 > 87.9x41.1 x 8.8mm

FA124-2 > 87.9x41.1 x 9.8mm

HONDA

RS 125/250	88-89	F
CBR 750 FH	87-88	F
VFR 750 FG/FH	86-87	F
CBR 1000 FH/FJ	87-88	F

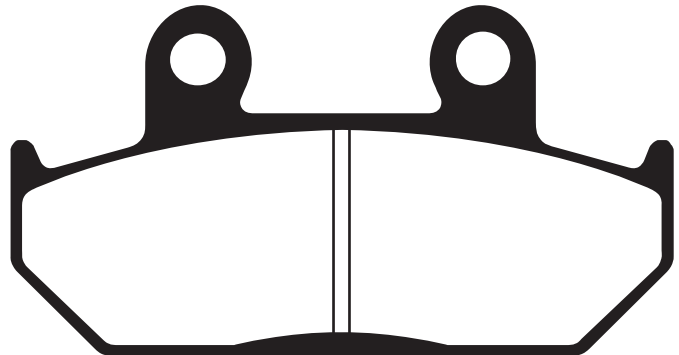

0-52

52x6.8mm

JAWA

350 Delanterra

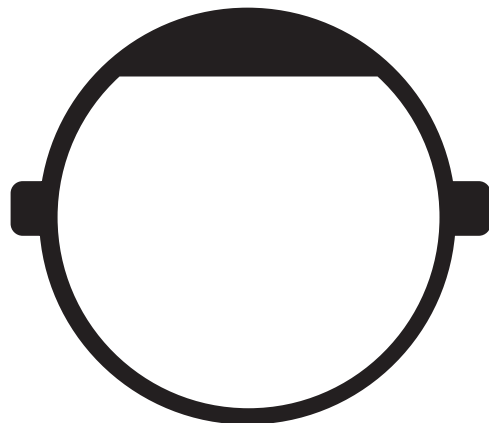

0-53

FA202

A > 96.7 x 43.4 x 7.6mm

B > 77 x 43.4 x 8mm

YAMAHA

XTZ 125

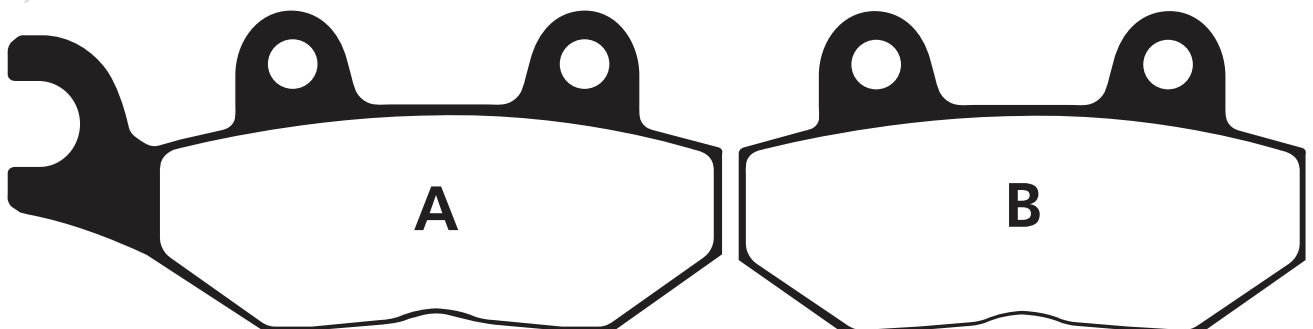

0-54

24 x 6mm

JUKI

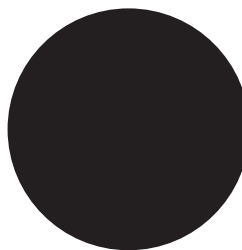

0-55

32.5 x 23 x 6mm

JUKI



0-56

58 x 54.2 x 9mm

SUZUKI

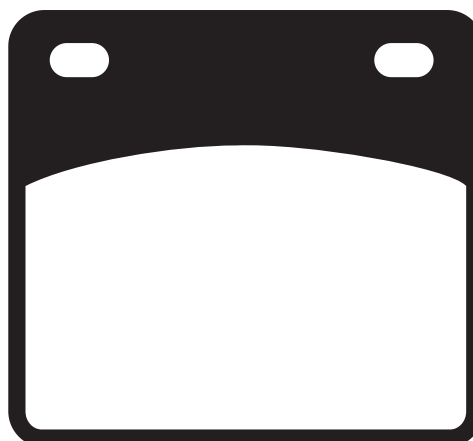

0-57

FA63

52.6 x 53 x 9mm

SUZUKI

GSF 400 M/N/P	91-93	R
GS 500 EK/EL/EM/EN/EPI	89-03	R
RF 600 RR/RS/RT/RV	94-97	R
GSX600 FJ/FK/FL/FM/FNI	88-03	R
GSX-R 600 WN/WP	92-93	R
GSF600 BanditST/SV/SW	96-98	R
GSXR 600 V/W/X/Y	97-03	R
SV 650 X/Y/K1/SK1	99-02	R
GSX 750 FK/FL/FM/FN	89-97	R
GSRX 750 RG/G/H/J/L	86-93	R
GSX-R 750 WR/WS/T/V	94-99	R
RF 900 RT/RV	96-98	R
TL 1000 SV/SW/SX/SY	97-01	R
GSXR 1100 G/H/J/K/L	86-92	R
GSF 1200 Bandit	97-03	R
GSX 1300 RX/RV/RK1	99-03	R

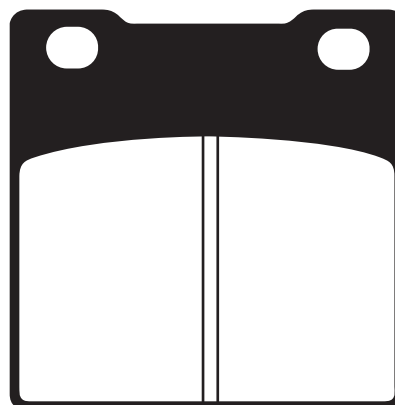

0-58**FA165****A** > 96.7x42x7.4mm**B** > 77.3x42x7.4mm**HONDA**

Twister CBX 250

KAWASAKI

Kaser 115

KLF 300 C1-C16 | 89-04 | F (right)

KLF 400 B1-B7 | 93-99 | F (right)

MOTOMEL

CG 125

Clipper

Custom 150

MZ

RT 125 | 02-03 | R

SX/SM 125 | 02-03 | R

SUZUKI

LT-F 300 FK2 (Right) | 02-03 | F

LT-F 500 FW/FX/FY | 98-02 | F

LT-A 500 FY/FK1 | 00-01 | F

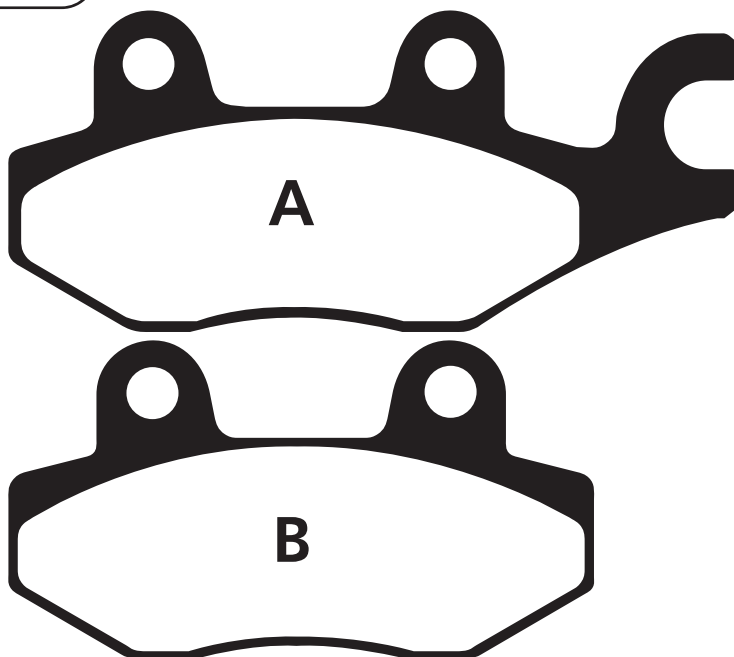
**YAMAHA**

YBR 125

0-59**FA104**

58x56x8.8mm

SUZUKI

SRX 250 T/TC | 87 | F

FZR 400 U/SUC/W | 88-89 | R

RZ 500 | 84-86 | R

FZ 600 S/SC/T/TC/U/UC | 86-88 | R

SRX 600 S/SC | 86 | F & R

XJ 600 S Seca II | 92-98 | R

**0-60****FA103**

58x53.5x8.7mm

SUZUKI

GSXR 250 CK | | F

GSX 400 R3 (GK71F) | | F

RG 400 | | F

VS 400 VR/FR/VTR | 94 | F

RG 500 G/CH | 85-87 | F

VS 600 GLS/GLT | 95-96 | F

VS 700 GLFH/GLPH | 86-87 | F

GSXR 750 F/G/H | 85-87 | F

VS 750 All Models | 85-91 | F

VS 800 GLN/GLP | 92-99 | F

GSXR 1100 G/H/J | 86-88 | F

GV 1400 CDG/GTG | 86 | F & R

VL 1500 W/X/Y/K1 | 98-01 | F & R

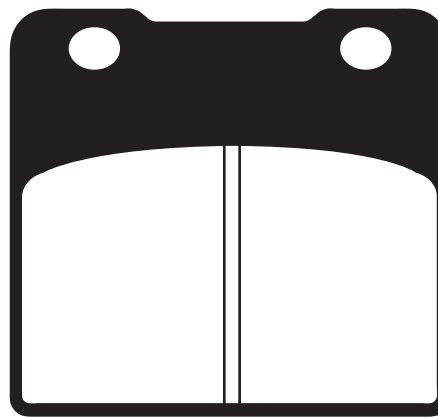

O-61

77.3x42.2x7.2mm

HONDA

CMX 250 C/CD Rebel 02-04 | R

KYMCO

Custom 125

MOTOMEL

Speedy

VA 150



O-62

FA158

46.7 x 69.8 x 8mm

KAWASAKI

ZX 600 D1-D4 (ZX6) | 90-93 | F

ZX 600 E1-E11 | 93-3 | F

ZX6 R | 94-97 | F

ZXR 750 H1/H2 | 89-95 | F

ZX 750 K1/K2/M1/M2 | 91-95 | F

ZX-9R B1/B2 | 94-95 | F

ZX 1100 C1-C4/D1/D9 | 90-01 | F

ZR 1100 A1/A2/A3 | 92-95 | F

ZZR 1200 | 02-03 | F

SUZUKI

GSXR 600 V/W/X/Y | 97-03 | F

SV 1000 K3/SK3 | 03 | F

TL 1000 SV/SW/SX | 97-01 | F

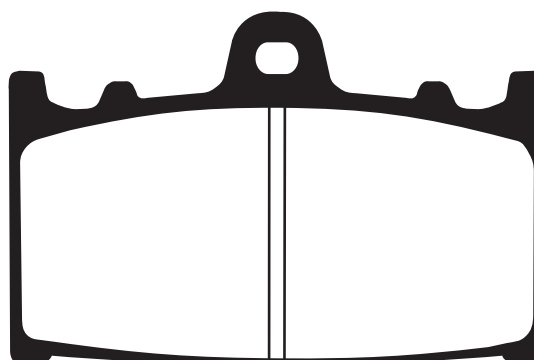

O-63

FA121

81.2x42x9mm

HONDA

CBR 250 FG/FGYA | 86 | F

CBR 250 RH | 87 | F

NSR 250 RG | 86 | F

CB 350 SG/SJ | 86-90 | F

CBR 400 RG | 86 | F

CBR RHYA | 87 | F

CB 450 SG/SJ | 86-88 | F

CBR 500 FH/FJ/FK/FL | 87-90 | F

CBR 600 FH/FJ/FK/FL | 87-90 | F

VFR 400 ZG/ZH/RG | 85-87 | F

VFR 400 RH2/RJ | 87-88 | F

XRV 750 L/M/N | 90-93 | F

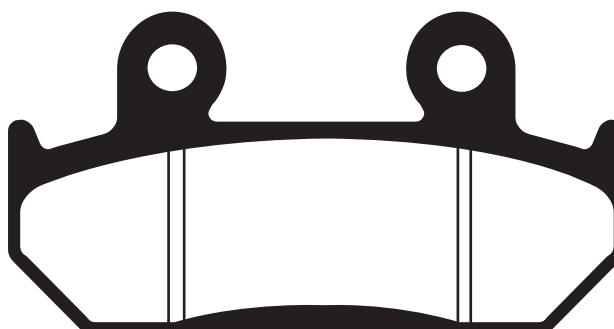

0-64

A > 85x43x8mm

B > 47.5x37x9mm

SUZUKI

ZZ 50



A

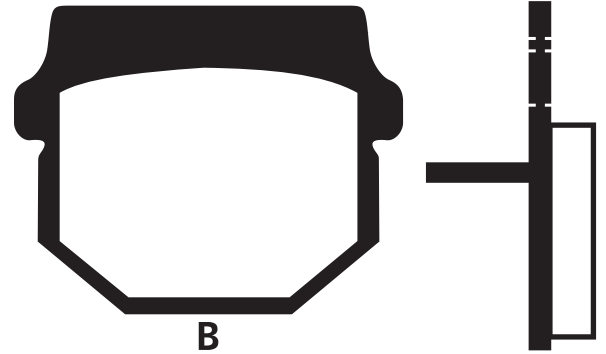

B

0-65

FA 157

A > 99.3x44x7.4mm

B > 47.7x83.3x9.7mm

YAMAHA

DTZ 125 Tenere	89-90	R
DT 125 Chesterfield	89-90	R

SUZUKI

RG 125 FUN/FUP/FUR	92-96	R
RG 125 UN	92-94	R
DR 650 RL/RM	90-91	R
DR 750 SK	89	R
DR 800 SL	90	R

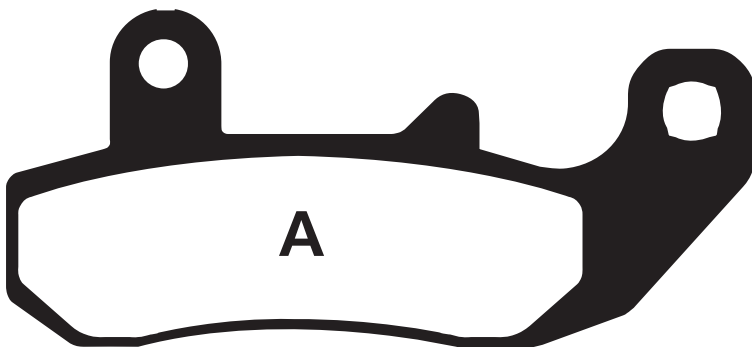

A

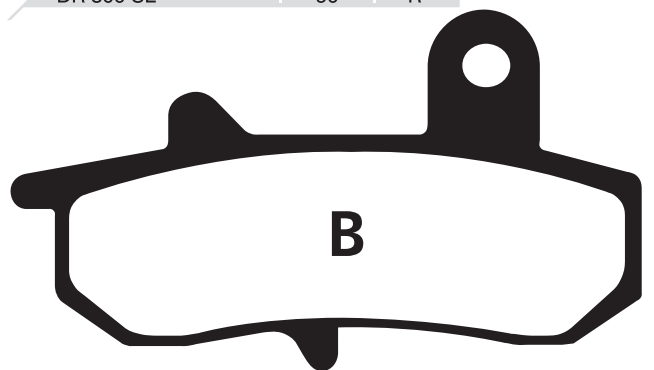

B

0-66

FA 81

68x60x10.5mm

SUZUKI

RD 80 LC	82	F
RX 115 (5FS3)	99	F
RD 125 LD	88-84	F
SR 125 SE	92-96	F
RX 135 (13X)	81	F
RZ 250 R (29L)	-	F
XV 250 Virago	89-94	F
RD 350 YPVS	83-84	F
XS 400	82	F
XZ 550	82-84	F
XT 600	84-86	F
XJ 650 Turbo	82	F
XJ 650 LK Seca	83	F

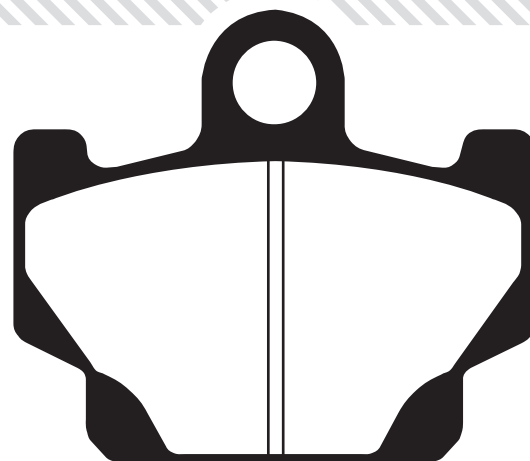

0-67**FA174**

86.3x41.4x10.2mm

HONDA

VTR 250 W/Y (MC33)	98-99	R
VRX 400 T (NC33)	96	R
CB 500 4/A4	04	R
CB 600 FW/FX "Hornet"	98-00	R
CBR 600 F3/F4/RR3	03-04	R
CB 750 F2N/F2R/F2S	92-02	R
CB 900 F2/F3/F4	02-04	R
CB 10000 FP/FR/FS/FT	93-97	R
CBR 1000 RR4	04	R
VTR 1000 FV/FW/FY	97-04	R
VT-R 1000 SPY/SP1	00-01	R
CB 1300 F3/F13	03-04	R
VTX 1300 S3/S4	03-04	R

SUZUKI

DL 650 K4 V-Strom	04	R
SV 650 K3/SK3/K4/SK4	03-04	R
DL 1000 K2/K3/K4	02-04	R

YAMAHA

YZF-R6	03	R
FZ6 Fazer	04	R

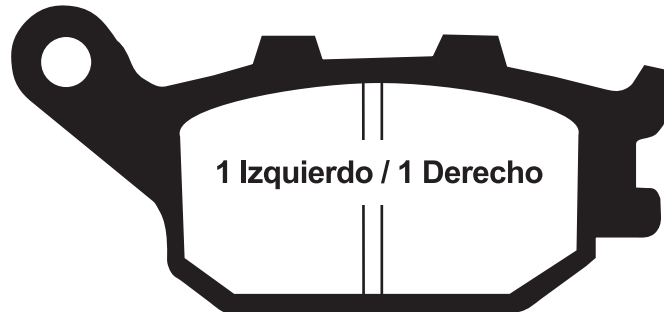
**0-68****A** > 85x43x8mm**B** > 47.5x37x9mm**SUZUKI**

DL 650 K4 V-Strom	04	R
-------------------	----	---

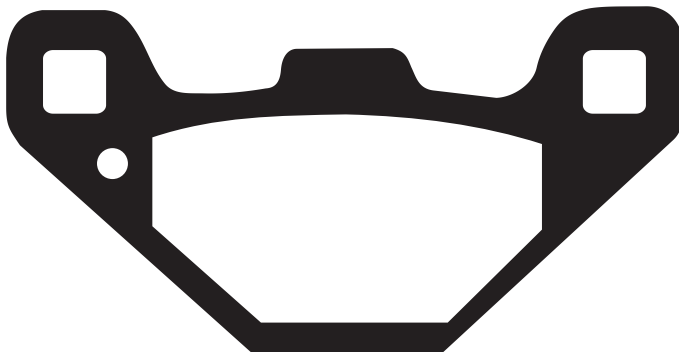
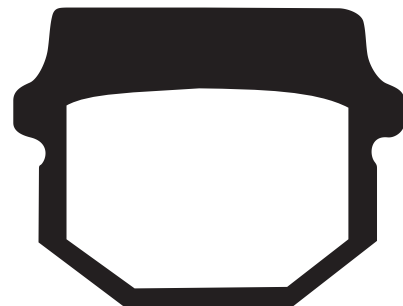
**A****B****0-69****FA92**

81x42x7.5mm

HONDA

CR 125 R	84-86	F
CR 250 R	84-86	F
XR 250 R Pro Link	84-87	F
XR 350 R	84-85	F
XL 350 R	84-85	F
CR 500 R	84-86	F
XR 500 R Pro Link	83-84	F
XL 600 R	83-87	F
TRX 250 R	86-89	F
ATC 250 R	85-86	F
ATC 350 X	85	F

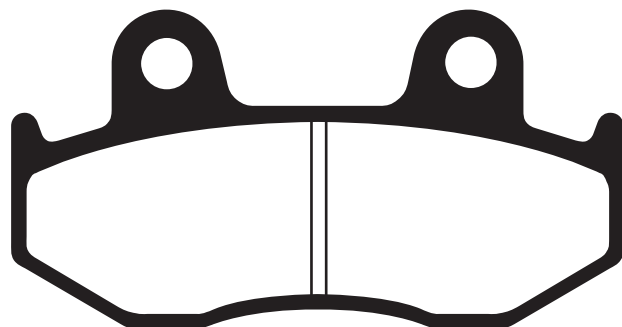

O-70**FA125**

94.2x32x7.3mm

HONDA

CRM 50 RN/RP/RR/RT	93-96	F
CRM 75 RK/RL/RM	89-94	F
CR 125 RH/RJ/RK/RL	87-94	F
AX-1 (NX 250 J/K/R/R3)	89-94	F
CR 250 RH/RJ/RK/RL	87-94	F
NX 250 J/K/L/ZL	87-93	F
TRX 250 RG/RH/RJ	86-89	F
XL 250 RL	90	F
XR 250 RJ/RK/RL	88-95	F
CR 500 RH/RJ/RK	87-84	F
XR 600 RJ/RK/RL/RM	88-91	F
XR Tornado 250	08	F

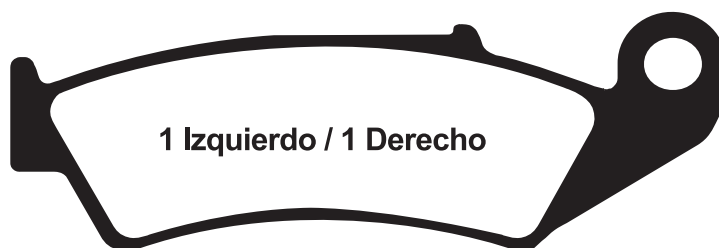

1 Izquierdo / 1 Derecho

O-71**FA147****A** > 118x48x8.6mm**B** > 97.5x57x10.8mm**SUZUKI**

DR 650 RSEM/RSEN	91-95	F
DR 650 RL/RM	90-91	F
DR 750 SJ/SK	88-89	F
DR 800 SL	90	F

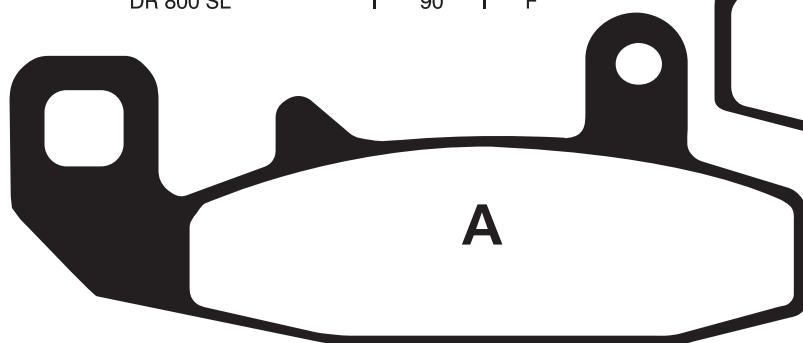

A

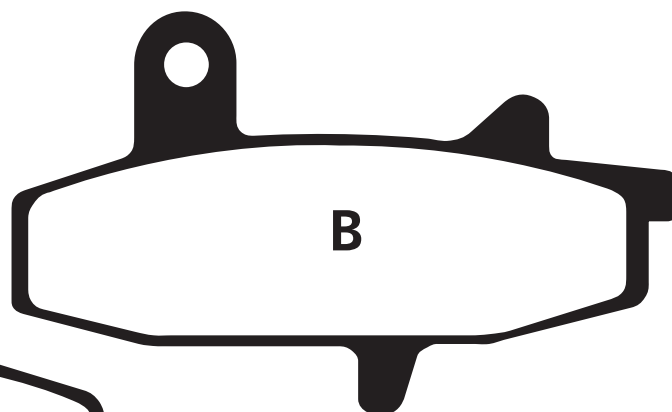

B

O-72**A** > 85x43x8mm**B** > 55.5x37x10.2mm**SUZUKI**

ZZ 50 Perno lado derecho

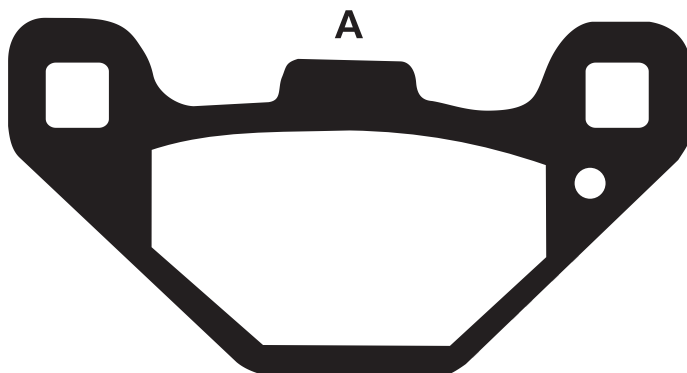

A

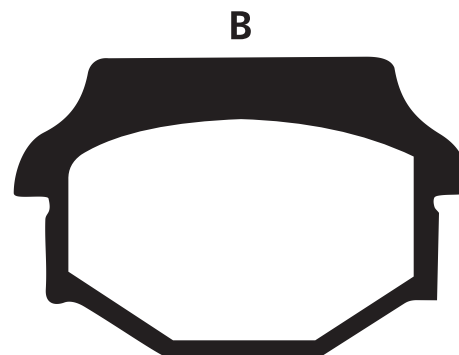

B

O-73

A > 85 x 43 x 8mm

B > 55.5 x 37 x 10.2mm

SUZUKI

ZZ 50 Perno lado izquierdo



O-75/O-142

FA84

46 x 45 x 7.8mm

HONDA

TRX 250 X	87-92	F & R
ATC 350 X	85-86	R
TRX300 EX Fourtrax	93-03	F & R
TRX400 EX Fourtrax	99-03	F & R
CD 80 R/RB Expert	86-02	F
CR 85R/85R Expert	03	F

KAWASAKI

KSF 250 A1-A17	87-03	R
KXT 250 B2 Tecate	87	R
KEF 300 A1/A2/A3/A4	95-00	R
KSF 400 A1 (KFX 400)	03	R
KX 80 L1-L3/N1/N2	88-00	R
KX 85 A1/A2/A3	01-03	R
KX 100 B5/B6/B7	95-03	R

SUZUKI

LT 230 EH/EJ/EK/EL	86-93	R
LT 250 SK/SL	89-90	R

YAMAHA

YFS 200 R Blaster	03	R
YFM 350 XT/XU/XW	87-03	R
YFZ 350 T/U/W/A/B	87-03	R
YFM 600 HM/HMC	00	F
YFM 660 RN/RP/RPB	01-03	F & R
YFM 660 FAP/FHAP	02-03	F
YZ 80 E/F/G/H/J/L/M/N	93-01	R
YZ 85 P/R	02-03	R
YZ 125 W	89	R
YZ 250 W/WRW	89	R

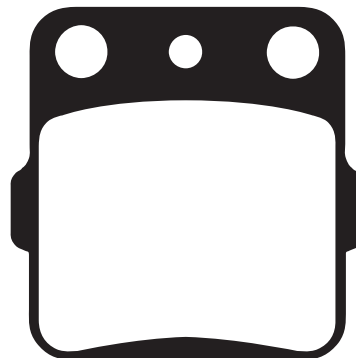

O-77**FA172****A** > 104 x 46 x 9.8mm**B** > 88 x 46 x 9.8mm**YAMAHA**

XT 600 E	92-03	F
XTZ 660 "Tenere"	91-98	F

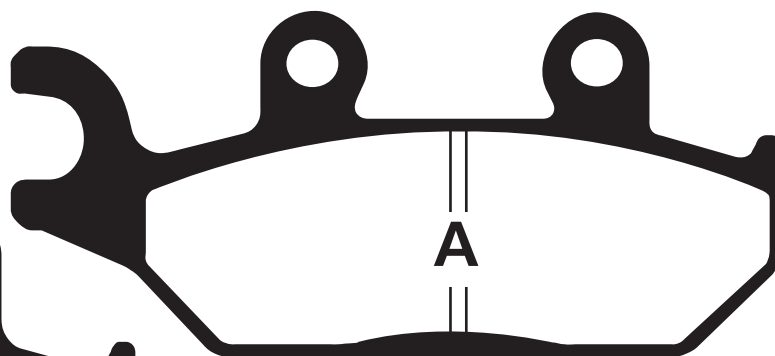
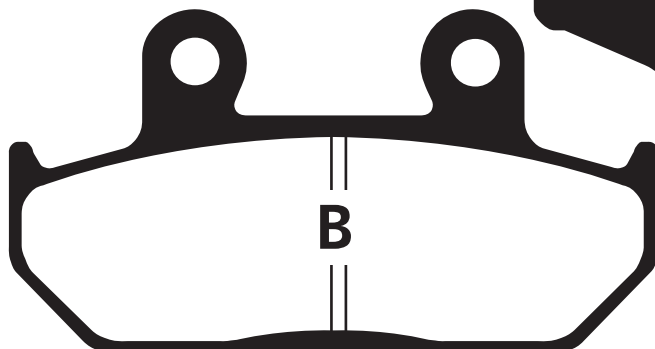
**O-78****FA80-2**

92 x 53 x 8mm

HONDA

CBX 550 FC/F2C/FD	82-84	F
-------------------	-------	---

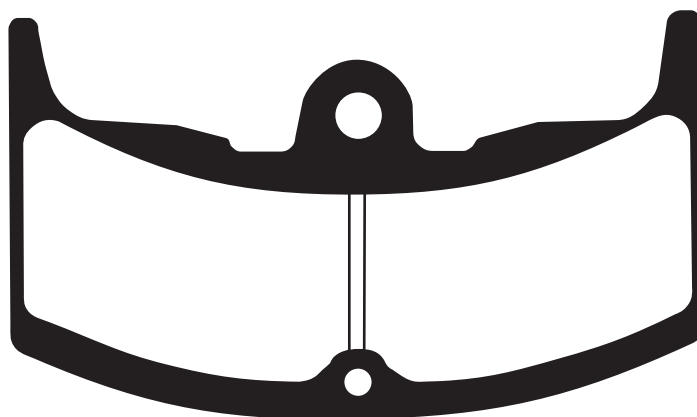
**O-80**

50.8 x 35.5 x 6mm

APRILIA

TX 125/300/311	85-86	F
TX 312	86	F & R

BENELLI

BKX 125	88	R
---------	----	---

DERBI

DS 50	89	F
CORPA FDT	85	F
YUMBO RD	87	F

GARELLI

CICLONE LC	86	F
323	86	F

BETA

ALP / KR 50	89	F
TR 125	89	F

SUZUKI

DR 50	88-90
CONDOR	89

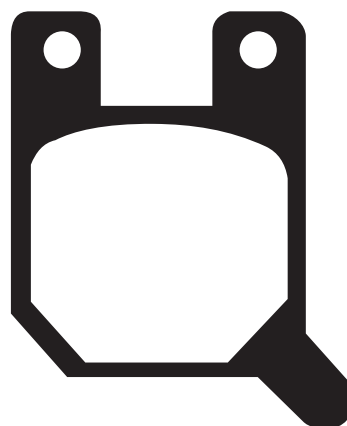

O-81**FA193**

39.8x51.2x7mm

APRILIA

SR (All Models)	97-02	F
Scarabeo 50/100	97-00	F & R
Scarabeo 50 (Di Tech)	98-03	F & R
SR 50 (All Models)	01-04	F

HONDA

SFX 50 S/T/V/W/X/Y/1	95-04	F
SGX 50 V/W/X/Y/1	97-03	F
SH 50 T	97-03	F
SRX 50 W/SW/X/SX	98-99	F

SUZUKI

AP 50 R/S/T/V/W	96-02	F
AY 50 V/W/W/WW	97-03	F
UX 50 WX/WY	99-02	F

YAMAHA

CS 50 P/R JogR	02-04	F
CW 50 NG/RS/RSP	95-98	F
YE 50 Zest	93-95	F
YN 50 R Neos	98-04	F
YQ 50 Aerox R	97-04	F
XN 125 Teos	00-03	F

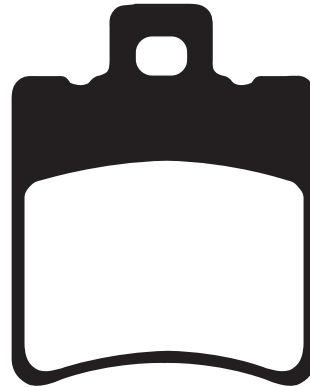
**O-83****FA90**

91x51x10mm

CIMATI

Gringo	85	F
--------	----	---

HONDA

CB 650 SCC	82	F
------------	----	---

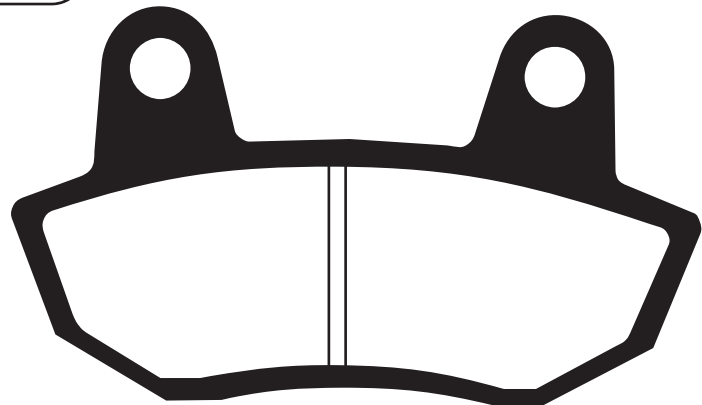
**O-85****FA70**

66.5x59x10mm

YAMAHA

RD 50 MX/RD 50	81-87	F
RD 80 (Air Cooled)	82	F
RD 250	80-83	F
RZ 250 (4L3)		F
RD 350 LX	81-82	F
XJ 550	81-84	F
XJ 550 H/J/K Maxim	81-83	F
XJ 550 RH/RJ/RK Seca	81-83	F
KJ 750	82-84	F
KJ 750 RF/RJ/RK Seca	81-83	F
XS 1100 S	81	F

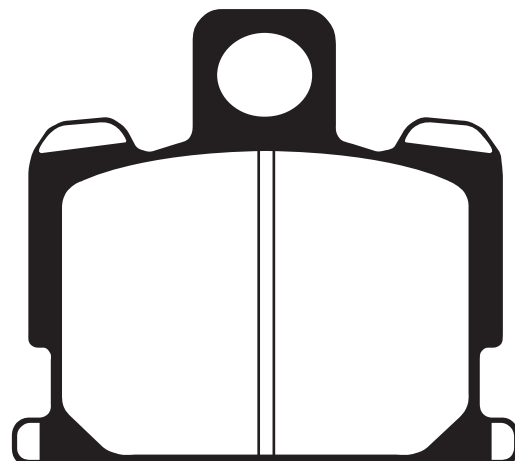

0-86 / 0-87**FA 192****A** > 90x51x8.5mm**B** > 68x52x9.5mm**KAWASAKI**

ZR 400 Zephyr	97-01	R
ZRX 400	95-01	R
ZZR 400	93-99	R
ZR 550 B4/B5/B6	95-01	R
ZZR600	93-04	R
ZX-6R	95-01	R
ZX6RR	03-04	R
ZX6R	02-04	R
Z 750	04	R
ZX-9R	94-01	R
ZX9R	02-04	R
Z 1000	03-04	R
GPZ 1100 E1/E2/F1	95-98	R
ZX 10 R	04	R
KLR 650	93-94	R
ZX 600 Ninja	93-94	R

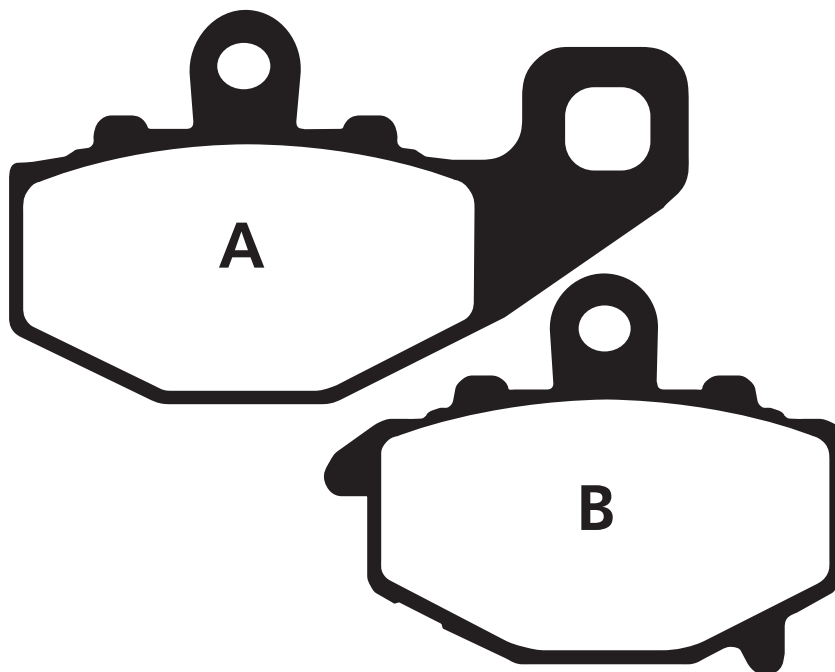
**0-89 / 0-136****FA 188**

66.5x59x10mm

KAWASAKI

ZX-6R	98-01	F
ZX-7R (ZX 750 P1-P7)	96-03	F
GPZ 900 R	99-02	F
ZX-9R	96-01	F
ZRX 1100 C1/C2/C3/C4	97-00	F
ZX12R	00-03	F
ZXR 1200 R	01-04	F
VN1500 / 1600	02-04	F

SUZUKI

GSXR 750 WR/WS	94-95	F
GSXR 1000 K1/K2	01-02	F
TL 1000 RW/RX/RV	98-02	F
GSF1200 SK1/K1/K2	01-04	F
GSX 1300 RX/RV/RK1	99-04	F
GSX 1400 K1/K2/K3	01-04	F
VZ 1600 K4	04	F

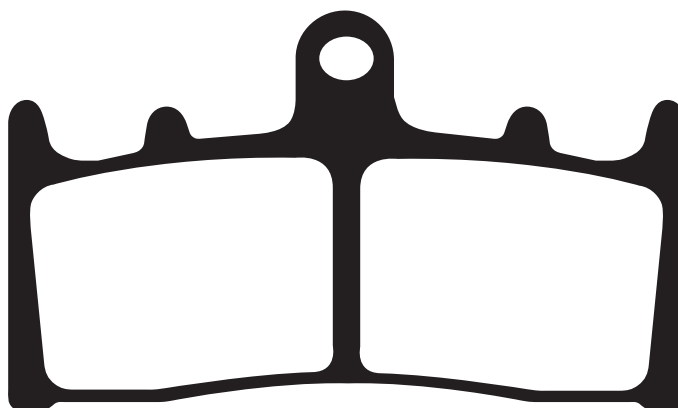
**0-90****FA 189**

125.5x45.1x9mm

HONDA

CBR1000 FP/FR/FS	93-99	F & R
------------------	-------	-------



0-91

FA106/106-2

SUZUKI

GZ 125 W/X/Y/K1/K2	98-04	F
RM 125/250 F/G	85-86	F
TU 125 X Super Classic	99	F
VL 125 Y/K1/K2/K3	00-04	F
TU 250 XV/XW	97-00	F
VL 250 Y/K1 Intruder	00-01	F
LS 650 Savage	87-99	F

FA106-2 SUZUKI

DR 600 SF/RG/RH	85-87	F
-----------------	-------	---

ZANELLA

Custom 125
Patagonia (algunos modelos)

FA106 > 77 x 54 x 7mm

FA106-2 > 77 x 54 x 9.5mm

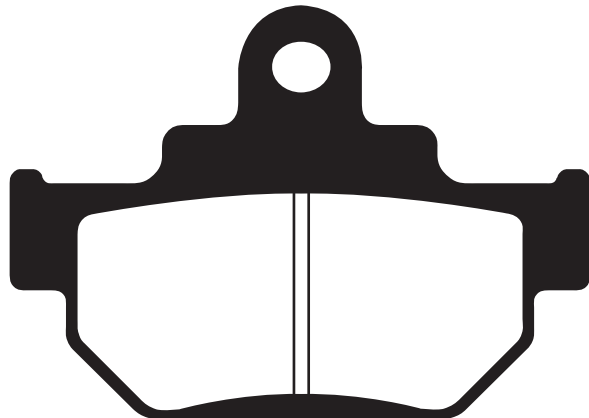

0-92

FA105

91 x 30.4 x 8mm

YAMAHA

YZ 125 N/S/T/U	85-88	F
YZ 250 N/S/T/U	85-88	F
TT 350 A (3GJ)	90-95	F
YZ 490 N/S/T/U	85-88	F
TT 600 W (59X)	89-92	F

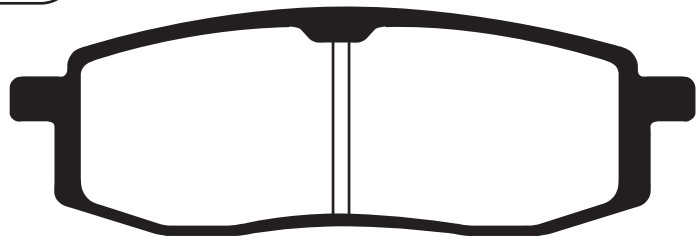

0-95

A > 88 x 35 x 8mm

MONDIAL

SUZUKI

125

ZANELLA

CHOPERA 125

CUSTOM

IMSA

125 - 150

HARFORD

125 - 150

JUKI

MOTOMEL

Hawker
CG 150
Custom 200



A

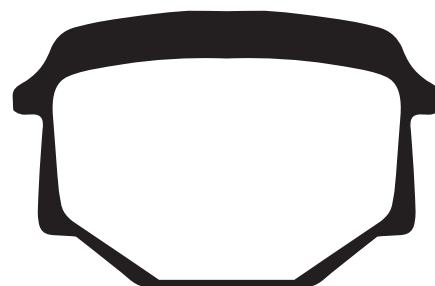

B

0-96**FA86**

77.3x42.2x7.2mm

GILERASmash 110
DLX 110**KYMCO**

125

MOTOMEL

Bit 110

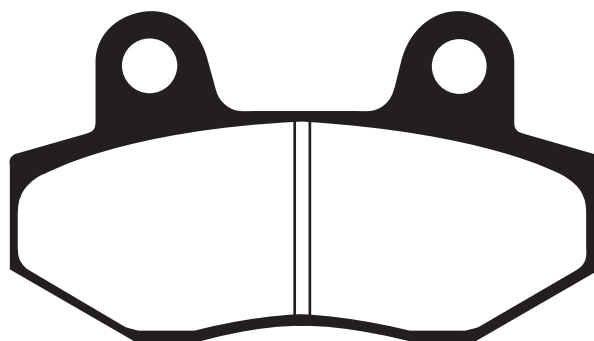
ZANELLAZB 110
Business**0-97 / 0-197****FA197****A** > 96.7 x 42 x 9mm**B** > 77.3 x 42 x 9mm**HONDA**

CB 50 V/W Dream 50	97-98	F
NSR 50 RV/RW/RX/RV	97-00	F
NRS 75 N/P/R/X/Y	92-00	F
NRS 80 P/R/S	93	F
Astra Supra NF 100	99	F
LS 125 RY	00	R
VT 125 CX/CY/C1/C21	99-04	F
XL125 V1/V2/V3/V4	01-04	F
NSR 150 RR		F&R
CBF 250 4	04	F

KYMCO

Spacer 50	99-03	F
Super 9 50 (AC/LC)	01-03	F
Sector 125	99-00	F
Zing 125/150	99-03	F
Grand Dink 125/150	01-03	F&R
Hipster 125/150	02	F
Cruiser 125		F
Bet & Win 250	00-04	F&R
Movie XL 125/150	01-04	F
People 250	03-04	F&R
Yup 250	03-04	F&R
Spike 125 R	04	F&R
Activ 110/125	04	F
Yager 125	00	F&R

KAWASAKI

BN 125 A3/A4/A5/A6	00-04	F
--------------------	-------	---

YAMAHA

TZR 50 Thunderkit	97-00	F
-------------------	-------	---

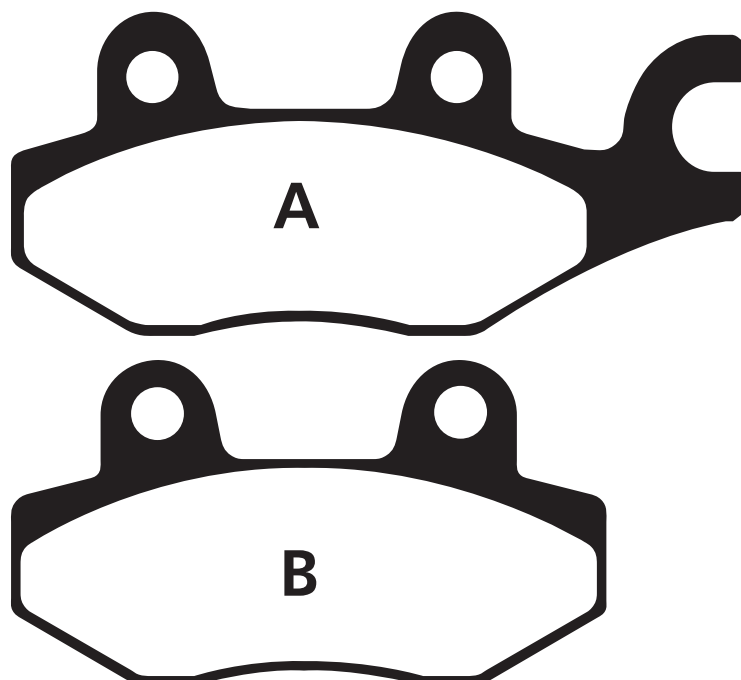

0-98**FA115**

36 x 45 x 6mm

ATK

560 | 97-98 | F

BETA

Eikon 50 Team	02-03	R
Synt/Gara	93-96	F & R
125 TR34-35	89-90	F
260 TR 34/35/Zero	89-92	F & R
Rev 50	02-03	F
Alp 200 4T		F & R

DERBI

Atlantis 50	02	F
GP1 50		F
Predator		F & R
Senda R 50	02-03	F & R

ITALJET

Dragster 50 LC	98-03	F & R
Formula 50	99-03	F
Torpedo 50	98-03	F
Formula 125 LC	96-03	F & R
Torpedo 150	03	F

KTM

60 SX	98-99	F
65 SX	00-01	F

PEUGEOT

Speedfight 2	02-03	F
--------------	-------	---

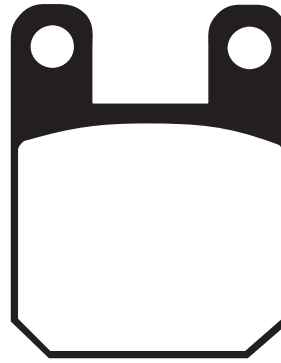
**0-99****FA275**

99.77 x 30.2 x 9mm

ITALJET

Jupiter 125/150 | 02 | R

YAMAHA

RZ 50 (5FC1/2)	02	F
T 105 E (5ER1/2)	99	F
V 110 ZE/ZK/ZHE	96	F
TW 125	99-04	F
TW 200	01-02	F
ST 225 (5BT) Bronco	97	F
YP 250 DX/A Majesty	98-03	R
YZF 600 R " R6"	99-02	R
YZF 1000 R1	02-03	R
Crypton	99-11	

MBK

YP 250 Skyliner | 98-02 | R

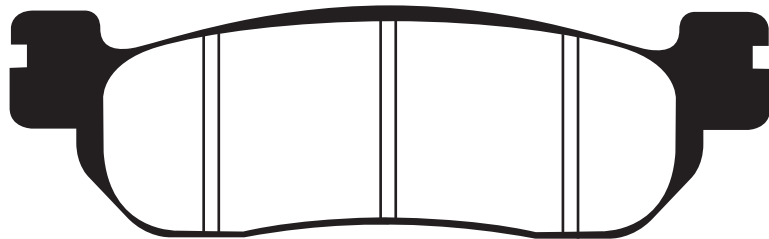

O-100**FA208**

78.13x41.2x9mm

APRILIA

650 ie | 01-04 | R

BMW

C1 125 | 99-03 | R

C1 200 | 01-03 | R

F 650/650 ST | 93-00 | R

F 650 GS/Dakar GS | 93-04 | R

F 650 CS | 00-04 | R

HONDA

CB 500 V/W/SW/X/SX | 97-03 | R

NX 500 V/W/X | 97-99 | R

FX 650 X/Y "Vigor" | 99-03 | R

SLR 650 V/W | 97-98 | R

NX 650 V/W/X | 97-98 | R

KTM

125 LC 2 | 98-01 | R

125 Sting | 98-01 | R

Duke (640cc) | 94-03 | R

All Models | 94-03 | R

Duke 950 | 03 | R

990 Duke | 04 | R

HUSQVARNA

All MX/Enduro | 95-04 | R

Dual 125 | 94 | R

SM All Models | 98-04 | R

YAMAHA

XT 660 X Supermoto | 04 | R

XT 660 R | 04 | R

BAJAJ

Rouser | | R

**O-102**

79x4x7.5mm

HONDA

NSR 125

NX 125 | 90-91

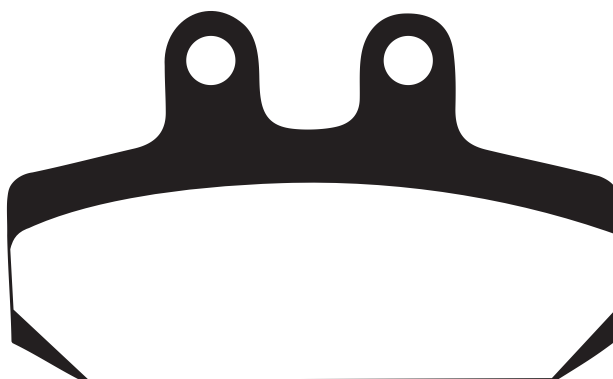

O-104

65 x 45 x 7.7mm

CUATRICICLO

STREET - CAR - Hidráulico

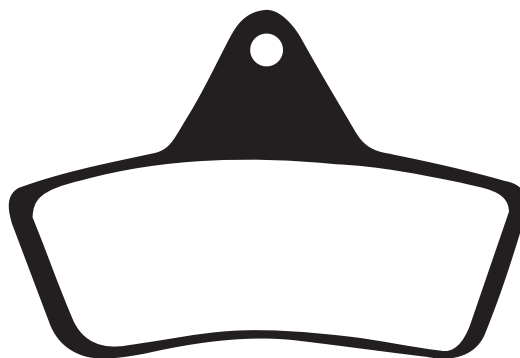

O-105 FA159

97 x 40 x 7mm

POLARIS

All Models | 89 | F

FAST TOYS/SMC

Quadzilla 300 | 04 | F



O-106

31.5 x 57.2 x 5.5mm

APRILIA

BETA

CAGIVA

GARELLI

KTM FANTIC

MTC

PEUGEOT

PIAGGIO



O-107**FA199**

93.8x40.3x9.8mm

YAMAHA

TDR 125 R	93-03	F
XV 125 "Virago"	97-00	F
SR 125	97-03	F
TZR 150 R	00	F
XV 250 S "Virago"	95-00	F
YP 250 DX/A/Majesty	98-03	F
YP 400 S Majesty	04	F
XJR 400	93-94	F
T-Max XP 500 S	04	F
FZ6 Fazer	04	F
XJ 600 S/N	98-03	F
XV 1100 Virago	99	F
XVS 1100 Dragstar	99-04	F

GILERA

QM 125

JIANSHE

JS 150

ZANELLA

Sexy

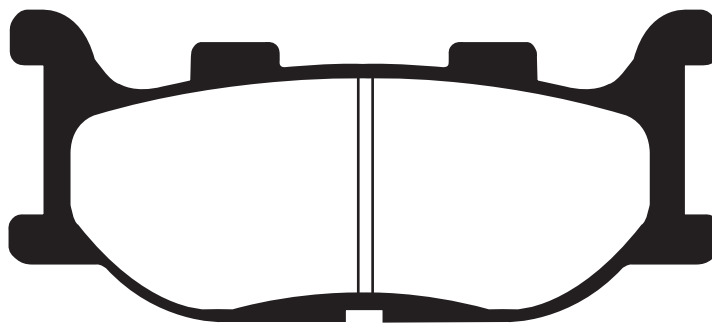
**O-108****FA60**

35.2x51.5x6mm

APRILIA

AF1 50	93-95	R
MX 50	03-04	R
RS 50	96-04	R
RX 50 C/CD	93-04	R
Tuorno 50	04	R
RX 50 Raing	04	R

MOTO GUZZI

250 (All Models)	75	F
------------------	----	---

CAGIVA

W4 50	91-95	R
WSXT 125	83-84	F
XSST 125	81-82	F
SXT 125	82	F
W8 125	93-98	R

FANTIC

50 Caballero	91	R
50.1 Oasis	86	R
50.1 Oasis E.S.	87	R
50 Koala		F & R
80 Caballero	91	R
80 Koala		F & R

MALAGUTI

50 MXR	89	F
--------	----	---

GARELLI

125 Tiger XLE	86	R
GTA 125	85	F
GTA 125	86	F & R

LAVERDA

Custom	82	F
125 Formula	86	F
CU 125 Ride	86	F
GS 125 Lesmo	90	F & R

MALANCA

125 ob one M6	85	F & R
125 ob one M6 Racing	85	F & R
125 Mark Enduro	85	F

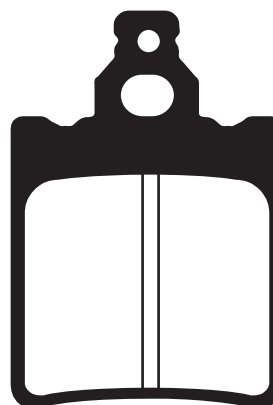

O-109

FA232

72.5x43.7x7mm

POLARIS

Rear pad most models | 89-00 | R



O-110

FA270R

73.85x52.8x6.82mm

POLARIS

Varios modelos

**FAST TOYS / SMC /
QUADZILLA / AIE**



O-111

35x6mm

PIAGGIO

84

VESPA

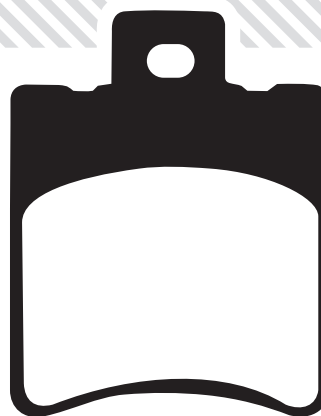

O-114

FA155

40x23/7.8mm

YAMAHA

YSF 200 B/F/G/H/J/K | 91-02 | R
Blaster | 88-02 |
Banshee

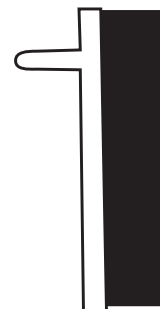
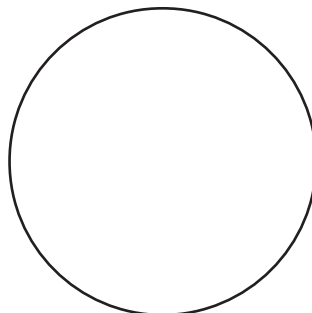

O-116

49x35.7x7mm

BETA

Cuadra | 93

HONDA

SFX 50 | 95

PEUGEOT

Buxi 50 | 94

PIAGGIO

Exagon 150 | 94

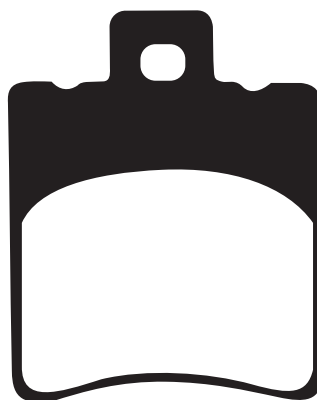

O-117 FA119

82.6x21.8x7.1mm

YAMAHA

DT 50 LC | 98 | F

YZ 80 S/T/U/W/E/F | 86-01 | F

YZ 85 P/LWP/R | 02-04 | F

TT-R 125 LWM/LWNI | 00-04 | F



O-119 FA194

A > 95.5x42x8mm

B > 77x42x8mm

APRILIA

MX 50 | 03-04 | F

RS 50 | 99-04 | F

RX 50 C/CD | 93-04 | F

RX 50 Racing | 04 | F

Tuorno 50 | 04 | F

ETX 125 | 99-01 | F

RX 125 | 92-99 | F

Pegaso 125 "Kat" | 94-95 | F

GILERA

DNA 50/125/180 | 01-03 | F

125 VX 4T/180/200 | 01-04 | F

Coguar | 00-01 | F

Runner 125/180 | 98-04 | F

MBK

TZR 50 X Power | 03-04 | F

DT 50 Supermotard | 03-04 | F

PEUGEOT

Elysar 125/150 | 03-04 | F

Elyseo 125/150 | 03 | F

Jet Force 125 | 03-04 | F

YAMAHA

DT 50 R | 04 | F

TZR 50 | 03-04 | F

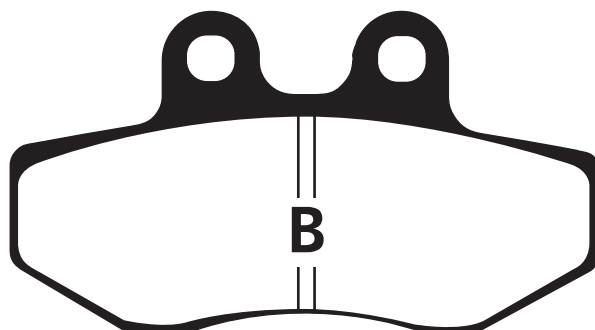
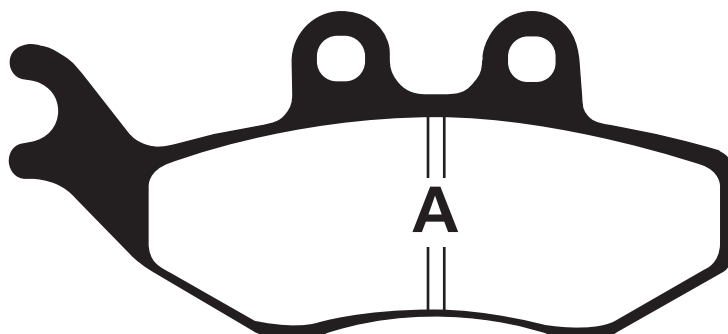

O-120

60 x 40 x 7mm

SUZUKI

ZZ 50 Perno lado izquierdo

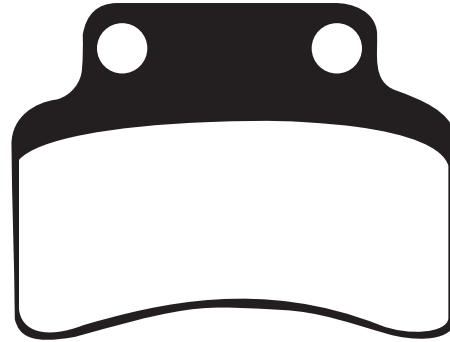

O-121

FA231/259

A > 133.5 x 36.8 x 8.4mm

B > 109.6 x 51.75 x 8.5mm

KAWASAKI

BJ 250 F1/F2 (250 TR)	02-03	F
ZR 250 B6 (Balius II)	02	F
ZR-X 400 E3	96	F (Right)
W 650	99-04	F
Z 750	04	F (Right)
ZR 750 D1 "Zephyr"	96	F (Right)
VN 800 C1/C2/E1/E2	99-03	R
KLV 1000	04	F (Right)
GPZ 1100 E1/E2/F1	95-98	F (Right)
ZR 1100 B1 "Zephyr"	96-97	F (Right)
VN 1500 G1/G2	98-99	F (Right)
VN 1600 A1/A2	03-04	F & R
VN 2000 A1	04	R

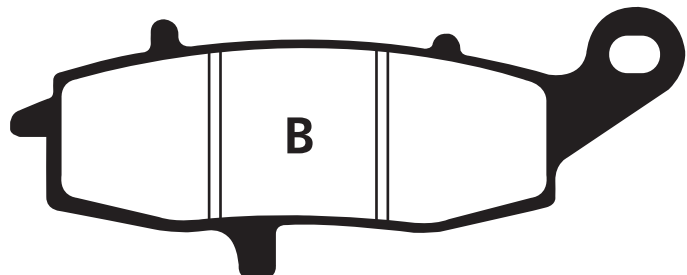
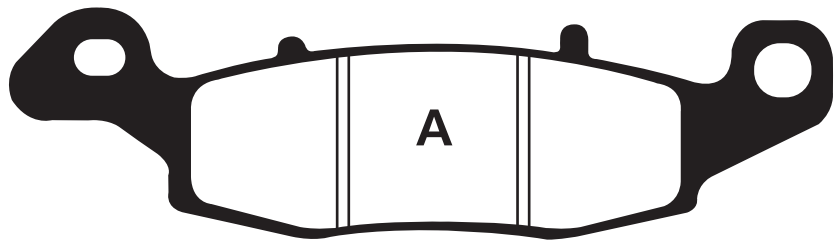

SUZUKI

RV 125 K2/K3/K4	02-04	F
GSX 250 FXK2	02	F
TU 250 XT/X/XTY	99-00	F
GS 500 ET/EV/EW/EX	96-04	F
DL 650 K4 V-Strom	04	F (Right)
SV 650 X/Y/K1/K2/K3	99-04	F (Right)
XF 650 V/W/X/Y	97-02	F
VL 800 K1/K2/K3/K4	01-04	F
VZ 800 V/W/X/Y/K1	97-03	F

O-122

FA229

A > 133.5 x 36.8 x 8.4mm

B > 109.6 x 51.75 x 8.5mm

SUZUKI

TU 250 GY/GBK1	00-01	F
GSX 600 FW/FX/FY/FK1	98-04	F (Left)
GSF 600 Y/SY/K1/K2	00-04	F (Left)
DL 650 K4 V-Strom	04	F (Left)
SV 650 X/Y/K1/K2	99-04	F (Left)
DL 1000 K2/K3/K4	02-04	F (Left)
VL 1500 K2/K3	02-03	F (Left)

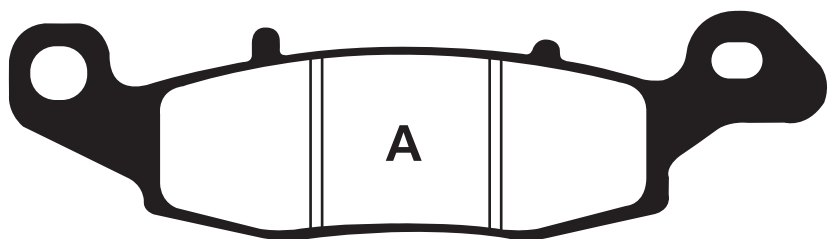

Continúa en página siguiente.

O-122 CONT.

KAWASAKI

ZR-X 400 E3	96	F (Left)
ER-5 ER 500 C1/C3/C4	01-04	F
KLR 650 C1-C8	95-04	F
ZR 750 D1 "Zephyr"	96	F (Left)
ZR-7	99-04	F (Left)
ZR-75	01-04	F (Left)
Z 750	04	F (Left)
VN 800 C1/C2/E1/E2	99-04	F
VN 800 B1-B9 Classic	96-04	F
KVL 1000	04	F (Left)
GPZ 1100 E1/E2/F1	95-98	F (Left)
ZR 1100 B1 "Zephyr"	96-97	F (Left)
ZR 1100 B5	02	F (Left)
VN 1500 D1/D2/E1/E2	96-99	F

VN 1500 G1/G2	98-00	F (Left)
VN 1500 J1/J2/R1/R2	99-04	F
VN 1500 N1/N2/N3	00-04	F
VN 1600 A1/A2	03-04	F (Left)

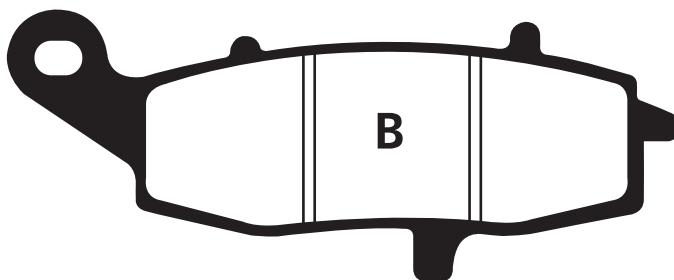

O-123

KARTING

Chasis - TUR - RAD - PCR

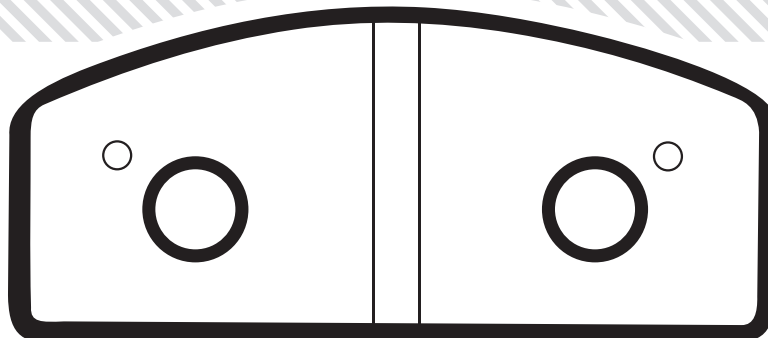

O-124

71 x 36 x 9.2 mm

GILERA

125 Aproche	91	R
RC 600	89-90	R

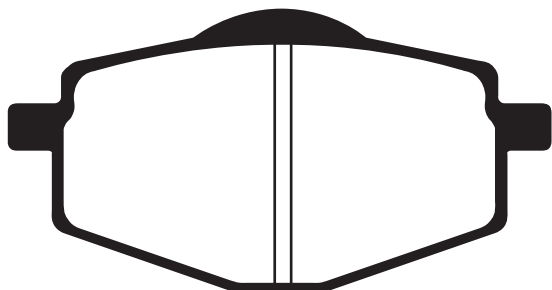

YAMAHA

TZR 50 Thunserkid	97-00	R
YSR 50 T	87	F
DT 125 LC	86-87	F
TDR 125 R	93-03	R
YZ 125 U	88	R
XC 125 TR	96	F
DT 200 (2LR)	87	F
XT 225 Serrow		F & R
YZ 250 U	88	R
XT 350	85-95	F
XT 600	87	R
YBR 125 (China)		

O-125

35 x 49 x 7mm

Equivalente a O-125

VESPA ROAD

ET2 50cc	97-05	F
LX 50	05-06	F
ET4 150cc	99-05	F
LX 150	05-06	F

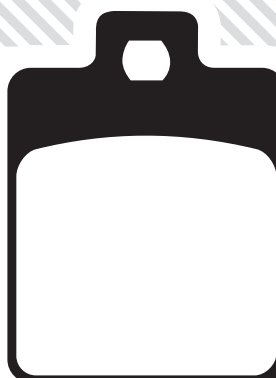

O-126 FA323-3

81 x 42 x 8.2mm

HONDA

NES 125 Y/1/2/3	00-04	F
SH 125 1/3	01-04	F
NES 150 Y/1/2/3	01-04	F
SES 125/150 2/3/4	02-04	F
CH 250 F/G "Spacy"	85-86	F

SUZUKI

AN 250 W/X/Y	98-02	R
AN 400 X/Y/K1/K2	99-04	R

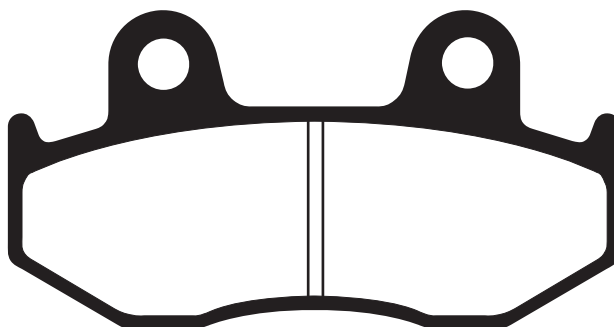

O-128 FA41

94.5 x 56mm

YAMAHA

RD 250 E/F	78-79	F & R
XS 250 SE/SF	79-81	F
RD 400 E/F	78-79	F & R
XS 400 SE	80-81	F
XS 750 SE	79-80	F (Right)



O-133 FA265HH/296

81 x 42 x 8.2mm

HONDA

CBR 900 RRW/RRX	98-03	F
VTR 1000 SPY/SP1	00-01	F
VTR 1000 SP-2/SP-3	02-04	F
CB 1300 F1 (SC40)	01	F

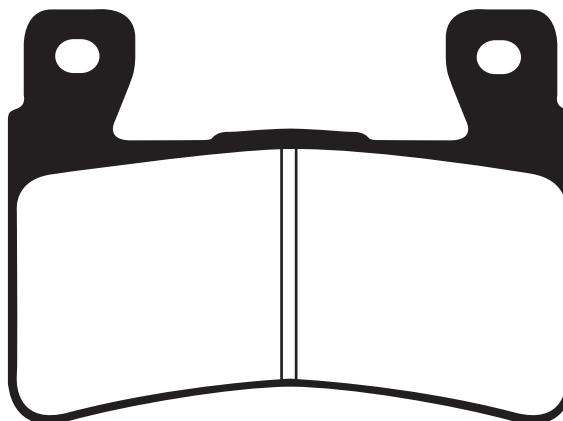

O-134 FA261HH

115.6x41x8.3mm

HONDA

NT 650 V2/V3/V4	02-04	F&R
VFR 800 Fi-W/Fi-X/A2	98-04	F&R
XL 1000 VX/VY/V1/V2	9-04	F&R
CB 1100 SFY/SF1 "XII"	00-04	F&R
CBR 1100 XXV/XXW	97-04	F&R
ST 1100 AT/AV/AW	96-01	F&R
ST 1300 2/A2/3/A3	02-04	F&R
GL 1800 A1/A2/A3	01-04	F&R
VTX 1800 C2/C3/C4	02-04	F&R

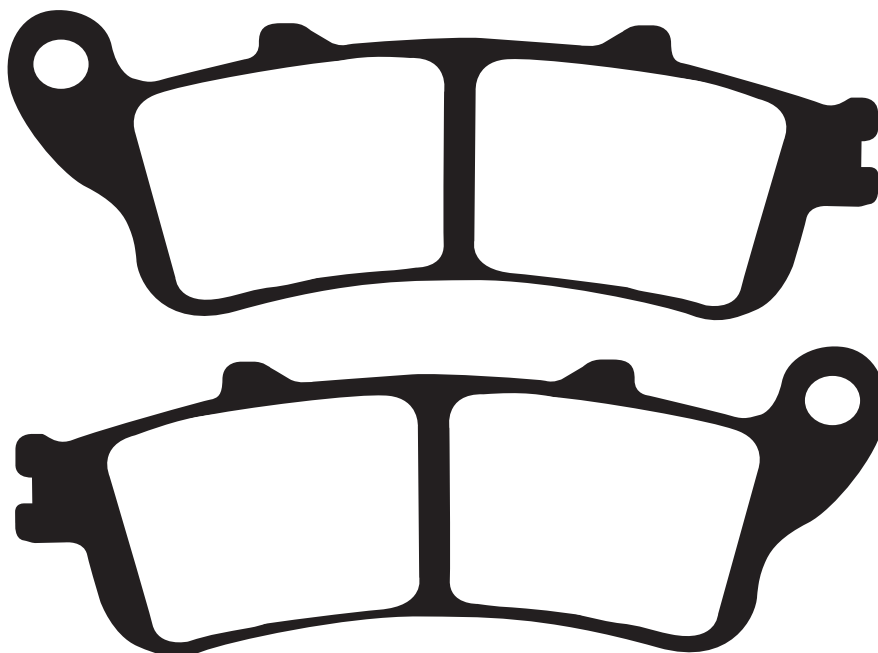

O-135 FA136

80x40x9.8mm

YAMAHA

XV 535 Virago	88-94	F
---------------	-------	---



O-137 FA351

36x39x6mm

APRILIA

Mini RX 50	04	F
------------	----	---

BETA

Minicross Pro Race 12	04	F & R
-----------------------	----	-------

FACTORY

Phantom R14 Agua	04	F
------------------	----	---

GAS-GAS

TXT 125/200/250/280	04	R
---------------------	----	---

SHERCO

All Models	01-03	R
------------	-------	---

MONTESA/HONDA

Honda 315 R	01-04	R
-------------	-------	---

SCORPA

TY-S 125 F Trials	03-04	R
250 Trial	00-04	R
SY 250 Long Ride	04	R



O-138 FA367X

66.9 x 36.1 x 10.75mm

KAWASAKI

KX 250 F (KX 250 N1) | 04 | R

YAMAHA

YZ 125 R/S | 03-04 | R

RM-Z 250 K4 | 04 | R

YZ 250 R/S | 03-04 | R

YZ 250 FR/FS | 03-04 | R

WR 250 FR/FS | 03-04 | R

WR 450 FR/FS | 03-04 | R

YZ 450 FR/FS | 03-04 | R

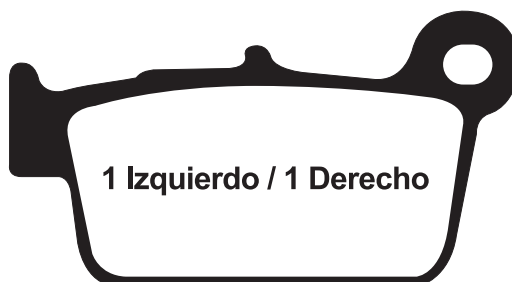

1 Izquierdo / 1 Derecho

O-139

FA209/209-2

FA 209 > 108.9 x 41.3 x 8mm

FA 209-2 > 108.9 x 41.3 x 8mm

HONDA

CB 500 V/W/SW/X/SX | 97-03 | F

NX 500 V/W/X | 97-99 | F

SRL 650 V/W | 97-98 | F

FX 650 X/Y "Vigor" | 99-03 | F

MOTO GUZZI

Quota 1100 ES | 99-00 | F & R

California/EV/Special | 99 | R

FA209-2 BMW

C1 125 | 99-03 | F

C1 200 | 01-03 | F

F 650/650 ST | 93-00 | F

F 650 GS/Dakar GS | 93-04 | F

F 650 CS | 00-04 | F

FA209-2 APRILIA

Pegaso 650/650 IE | 97-04 | F

ETV 1000 | 01-04 | F



1 Izquierdo / 1 Derecho

O-141 FA132

79.6 x 46.5 x 9mm

KTM

Most 1988 Models | 88 | F & R

Enduro Models | 89-91 | F & R

250/300 E/XC/GS | 90-91 | F

125/350 E/XL/GS | 90-91 | F & R

125/250/300/600 | 92-93 | F

125/250/400/600 LC | 89-91 | F & R

MAICO

All Models | 89-93 | F & R

250 MX | 94-98 | F & R

500 MX | 94-98 | F



OSSA

500 | 92 | F

O-150 FA150

57.3x59x9mm

MAICO

GV 1400 GDG / GCG / 86-88 R
GDH / GDJ / GCH
"Calvacade"

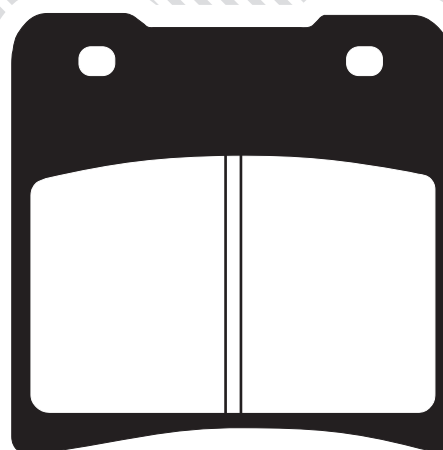

O-161 FA161

52.6x52.7x8mm

KAWASAKI

Z 250 A1/A2/A3	78-81	R
ZXR 400 J1/J2	89-90	R
ZXR 750 H1/H2/J1/J2	89-95	R
ZX-7R	96-03	R
ZZR 1100 D1-D9	93-01	R
ZRX 1100	97-00	R
ZX 12R	00-03	R
ZRX 1200 R	01-04	R
ZZR 1200 C1H/C2H	02-04	R
ZX 12R	04	R

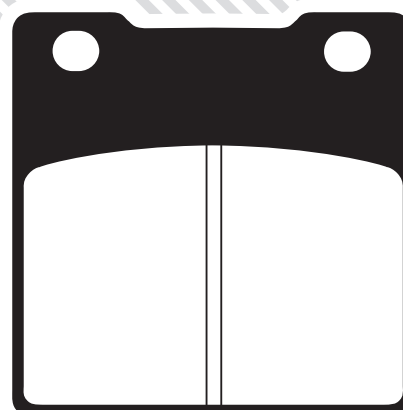

O-170 FA170

Ver O-407

99.8x55.8x8.3mm

O-171 FA171

57.7x53.7x8.9mm

BMW

K 75/75-2	09/88-96	F
K 75/75-S	08/09-96	F
K 75 C	09/88-02/88	F
K 75 RT	89-96	F
K 75 S	09/88-95	F
K 100/2	09/88-90	F
K 100 LT	09/88-91	F
K 100 RS	10/88-89	F
K 100 RT	10/88-89	F
R 80 / R 80 RT	09/88-95	F
R 100 RS	9/9-92	F
R 100 RT	09/88-95	F

QUADZILLA

RL 500 Buggie	08-09	F&R
---------------	-------	-----

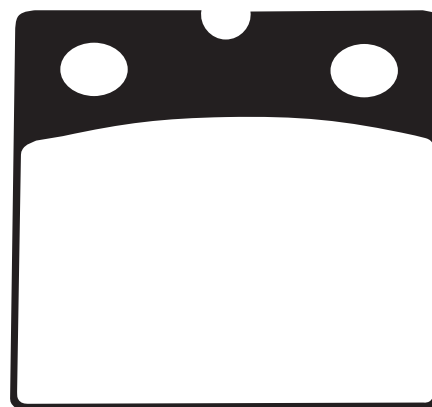

O-181 FA181

94x37.3x7.5mm

KTM

All Models | 92-03 | F

GAS-GAS

Wild HP 300/450 | 03 | F & R

HUSABERG

All Models | 93-03 | F

HUSQVARNA

All Models | 95-03 | F

ATK

All Models | 97 | F

MAICO/M-STAR

Disc Models | 97-99 | F

YAMAHA

FZ 16 | | F

BAJAJ

Rouser | | R

TM

MX Models 85/100 | 02-03 | F
Enduro 125/8250/300 | 02-03 | F

VERTEMATI

495 | 99-02 | F
C 450/500/570 | 03 | F
E 450/501/570 | 03 | F

V.O.R.

All Models 2 piston | 99-02 | F

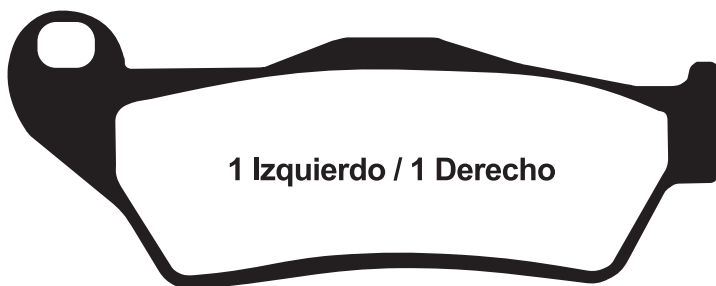

O-182 FA182

74.8x53.9x10mm

YAMAHA

FZR 1000 EX UP | 91-93 | F

Diámetro de los agujeros 6 mm

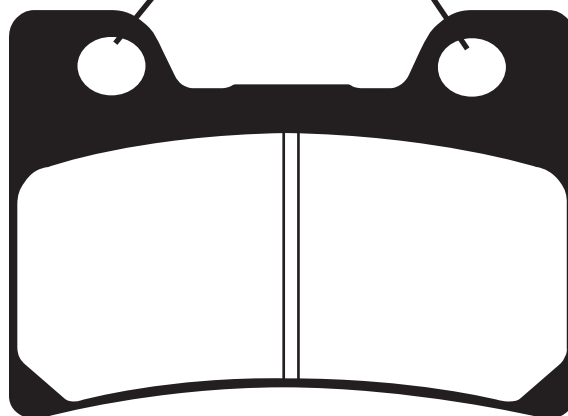

O-187 FA187

68x54x8 mm

BMW

K 75/75-2 | 09/88-96 | F
K 75/75-S | 08/09-96 | F
K 75 C | 09/88-02/88 | F
K 75 RT | 89-96 | F

Continúa en página siguiente.

O-187 CONT.

> 68x54x8 mm

BMW

K 75 S	09/88-95	F
K 100/2	09/88-90	F
K 100 LT	09/88-91	F
K 100 RS	10/88-89	F
K 100 RT	10/88-89	F
R 80 / R 80 RT	09/88-95	F
R 100 RS	9/9-92	F
R 100 RT	09/88-95	F

QUADZILLA

RL 500 Buggy	08-09	F&R
--------------	-------	-----

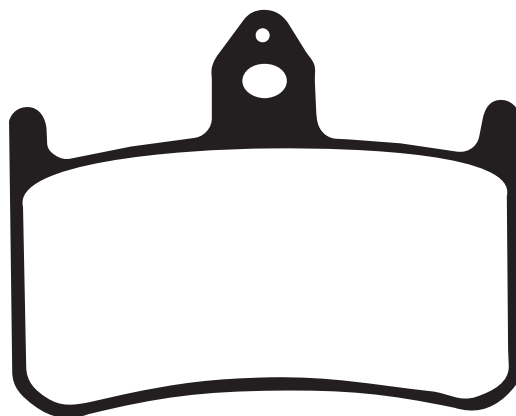

O-196 FA196

101 x 39 x 9.8mm

HONDA ROAD BIKE

FSC 600 / A Silverwing	02-07	R
VT 600 C/CD/CD2	94-07	F
VF 750 C Magna	94-03	F
VFR 750 F	90-97	R
CB 750 Nighthawk	91-03	F
VT 750 C/CD/CD2	98-02	F
VT 750 CD/CD/DCA	01-07	F
VT 750 CDA/CDB/CDC	02-03	F
VT 750 Shadow Aero	04-07	F
CBR 1000 F	90-91	R
ST 1100	91-02	R
ST 1100 A "ABS Model"	95	R
VT 1100 C Shadow	94-07	F
VT 1100 C2 A. Classic	95-07	F
VT 1100 T S. A. Classic	98-01	F
VTX 1300 C	04-07	F
VTX 1300 S	03-07	F
VTX 1300 R	05-07	F
GL 1500 C/CT/CF/CD	97-03	R

TRIUMPH

Adventurer		F & R
Bonneville America	02-06	F
Bonneville 800	01-05	F
Bonneville T100	02-07	F
Legend TT	98-01	F & R
Speedmaster 800	03-04	F
Speedmaster (865cc)	05-07	F
Thunderbird	95-03	F & R
Thunderbird Sport	98-03	F & R
Tiger (885cc)	97-99	F & R
Tiger 955cc	00-04	F & R
Tiger 955 (Cast wheel)	04-06	F
Scrambler (865cc)	06-07	F

KYMCO

Venox 250	03-07	F
Xciting 250	05-07	R
Xciting 500	04-07	R

KYMCO

Venox 250	03-07	F
-----------	-------	---

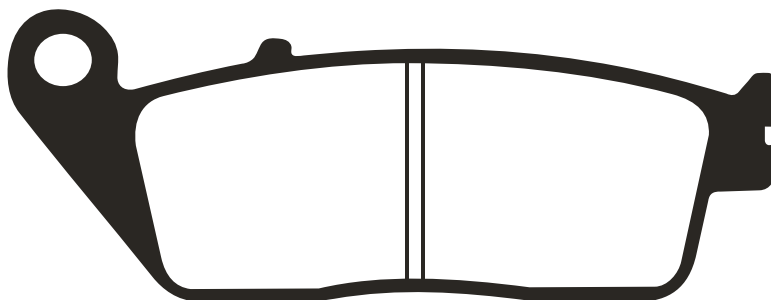

1 Izquierdo / 1 Derecho

O-200**FA200**

104x62.4x11.2mm

HARLEY DAVIDSON

FXST/FXSTB/FXSTC | Late 87-89 | R

XL/XLH/XLCH | Late 87-99 | R

FXD/FXDL/FXDWG | Late 87-99 | R

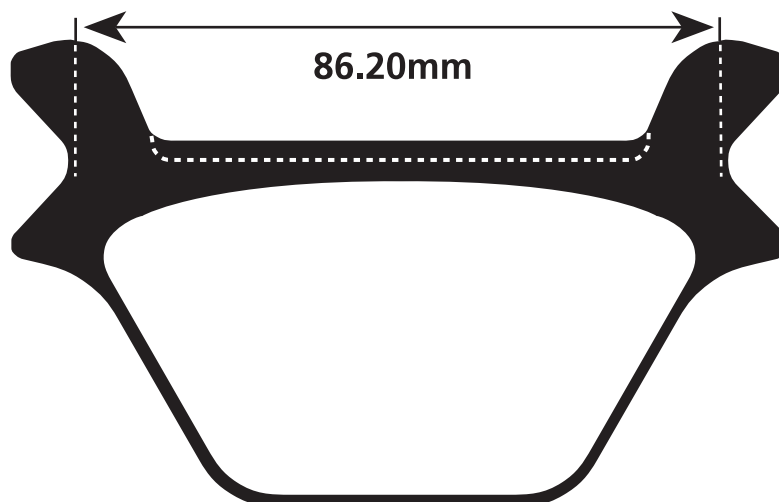
**O-203****FA203**

81.2x42x9.5mm

HONDA

CBR 600 FM/FN/FP/FR | 91-94 | F

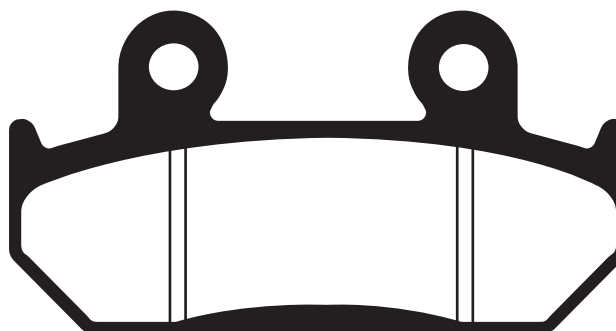
**O-213****FA213**

78.13x41.2x9mm

APRILIA

Pegaso Strada 650 | 05-06 | R

Pegaso 650 Trial | 06-08 | R

Pegaso 650 | 07-08 | R

Pegaso 650 Factory | 06-08 | R

Dorsoduro Factory 750 | 10-11 | R

Shiver 750 GT | 09-10 | R

Shiver 750 | 07-10 | R

Shiver 750 (RAE00) | 10-11 | R

Shiver 750 GT ABS | 10-11 | R

Dorsoduro 750 | 08-11 | R

Dorsoduro 1200 | 11 | R

Dorsoduro ATC/ABS | 11 | R



Continúa en página siguiente.

O-213 CONT.

78.13x41.2x9 mm

BETA

Jonathan 125	00-01	R
Euro 350	00-01	R

BMW

C1 125	99-03	R
C1 200	01-03	R
F 650 (E169/0161) Standar	09-93/96	R
F 650 (E169/0162)(Funduro/ High Screen/19" front wheel)	97-00	R
F 650 CS Scarver (K14/0174/ 0184-Belt Drive/17" cast wheels)	00-03	R
F 650 CS Scarver (K14/0177/ 0187-Belt Drive/17" cast wheels)	04-07	R
F 650 ST(E169/0163/168)Strada (18" front wheel/low screen)	97-00	R
F 650 GS (R13/0172/0182) (19" front wheel)	99-03	R
F 650 GS Dakar(R13/0173/0183) (21" front wheel)	99-03	R
F 650 GS (R13/0175/0185) Single cylinder	04-07	R
F 650 GS Dakar(R13/0176/0186) (21" front wheel)	04-07	R
F 650 GS (K72/0218/0228) (798cc Twin cylinder/cast wheel)	07-11	R
F 650 GS (30 years GS) (798cc Twin cylinder/cast wheel)	11	R
G 650 Xchallenge	07-09	R
G 650 Xmoto	07-09	R
G 650 Xcountry	07-09	R
G 650 GS (R131)(Single cylinder chain drive)	09-11	R
F 800 GS	08-11	R
F 800 GS (30 years GS)	11	R
F 800 R	09-11	R
F 800 R Chris Pfeiffer Edition	09-11	R
F 800 S (Half Fairing)	06-10	R
F 800 ST (Full Fairing)	06-11	R
F 800 ST Touring	10-11	R
S 1000 RR	10-11	R

DUCATI

Paul Smart1000 Limited	06-07	R
Paul Smart 1000 LE(992cc)	06	R
1000 Sport (992cc)	06-07	R
Classic Sport Biposto (992cc)	07	R
GT 1000 (992cc)	07-10	R
GT 1000 Touring (992cc)	09	R
Sport 1000 S (992cc)	07	R
Sport 1000 S	07-09	R
Sport Classic 1000 (992cc) (Monoposto-Japan/Biposto Europe)	06-08	R



HONDA

CB 500 V/W/SW/X/SX/Y/SY/2/S2	97-03	R
NX 500 V/W/X Dominator	97-99	R
FX 650 X/Y "Vigor"	99-03	R
S LR 650 V/W	97-98	R
NX 650 V/W/X Dominator	97-99	R

KTM

Duke 125 (4T)	11	R
Duke-E 640 (Single pin pad fixing / Zero offset disc)	98	R
Duke II 640 (2 pin pad fixing/ Zero offset disc)	99-07	R
690 Duke	08-11	R
690 Duke R	10-11	R
690 Rally Factory Replica	07-09	R
690 S M	07-09	R
690 S MR	07-11	R
690 S MC	07-11	R
690 SM-LE (Limited Edition)	10-11	R
990 Superduke	05-11	R
990 Superduke R	07-11	R

YAMAHA

WR 125 X	09-11	R
WR 125 R	09-11	R
WR 250 XX/XY Supermoto (32D2/4)	08-10	R
WR 250 RX/RV (32D1/3)	08-10	R
XT 660 X Supermoto	04-11	R
XT 660 R	04-11	R
MT-03 (660cc)	06-11	R

O-214

FA214/214-2

FA214 A > 96.7 x 42 x 7.6mm
B > 77.3 x 42 x 8mm

FA214-2 A > 96.7 x 42 x 9.7mm
B > 77.3 x 42 x 8mm

FA214 TRIUMPH

Speedmaster 800	03-04	R
Sprint 900	93	F
Tiger	93-96	F
Trident 900 / 750	92-98	IF (Left)
Trophy 900	92	F (Left)
Trophy 1200	93-01	IF (Left)

FA214-2 TRIUMPH

Bonneville 800	01-04	R
Bonneville T100	02-04	R
T595 Daytona	97	R
Daytona 955i	98-00	R
Speed Triple	97-01	R
Speed Triple 955 cc	02-04	R
Sprint RS	99-04	R
Thruxton 900	04	R

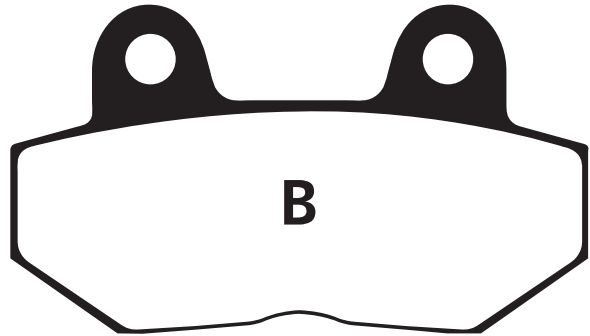
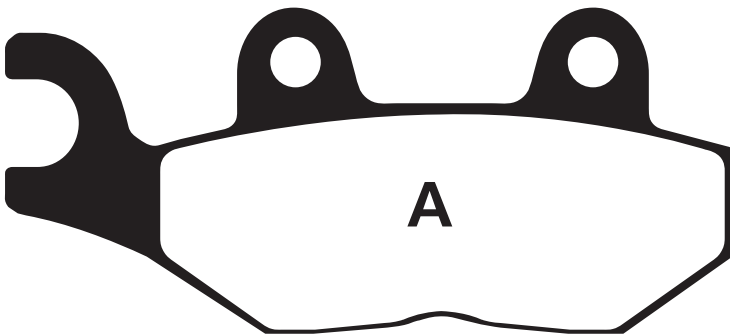

O-215

FA215/215-2

FA214 A > 96.7 x 42 x 7.6mm
B > 77.3 x 42 x 8mm

FA214-2 A > 96.7 x 42 x 9.7mm
B > 77.3 x 42 x 8mm

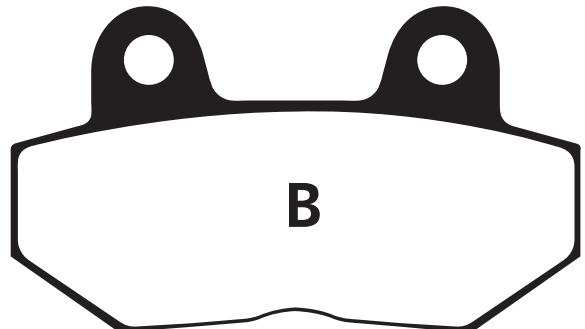
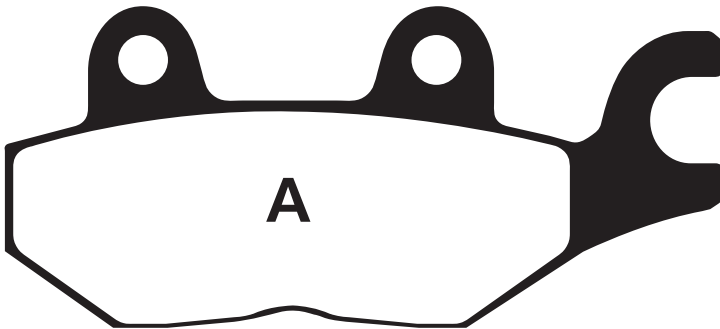

FA214 TRIUMPH

Speedmaster 800	03-04	R
Sprint 900	93	F
Tiger	93-96	F
Trident 900 / 750	92-98	IF (Left)
Trophy 900	92	F (Left)
Trophy 1200	93-01	IF (Left)

FA214-2 TRIUMPH

Bonneville 800	01-04	R
Bonneville T100	02-04	R
T595 Daytona	97	R
Daytona 955i	98-00	R
Speed Triple	97-01	R
Speed Triple 955 cc	02-04	R
Sprint RS	99-04	R
Thruxton 900	04	R

O-226**FA226**

102x38x9mm

HONDA

RS 125	90-94	F
RS 250	90-94	F
CBR 600 FS/FT/FV/FW	95-98	F
CBF 600 4/A4		F

**O-230****FA130****A** > 73.3x49.3x7mm**B** > 60.8x62.8x9mm**KAWASAKI DIRT BIKE**

KX 125 E2/F1	87-88	F
KX 250 E1/F1	87-88	F
KX 500 C1/D1	87-88	F
KL 650 A1-A19/A6F/A7F	87-07	F

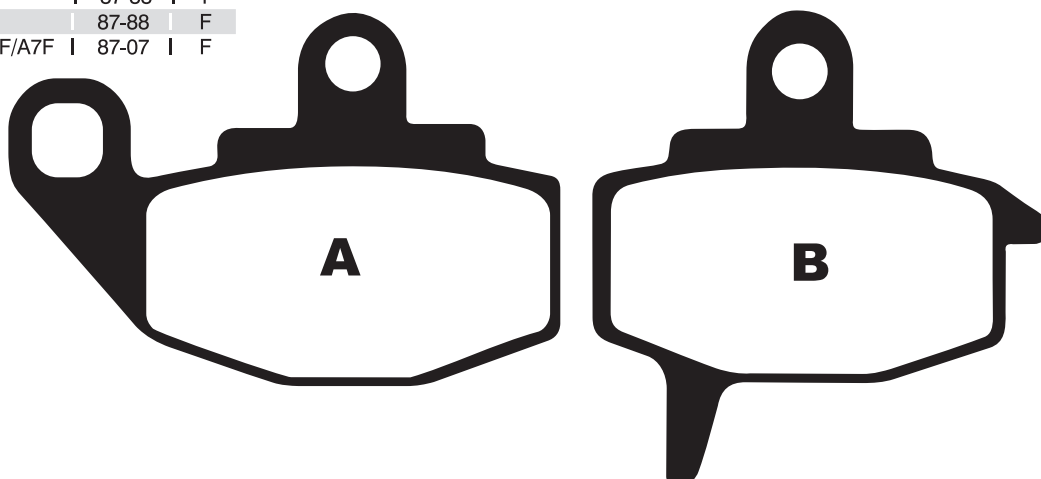
**O-233****FA233**

75.1 x 37.2 x 9.5mm

KYMCO

Cobra 50 Racer/Cross	99-04	F
CX 50 Super	94-97	F
K12 Sport 50	95-00	F
KB 50 (SE10CA)	95-00	F
Looping 50	98	F
Top Boy 50	97-00	F
ZX 50 Super	99-04	F
Scout 50	98-02	F
Filly 50 LX	00-02	F
Sniper 50	93	F
Vitality 50	04	F
KB 100 Manboy	97-00	F



O-235 / O-228

FA135

A > 96.7 x 42.7 x 7.4mm

B > 77 x 42.2 x 7.4mm

KAWASAKI

KX 125 G1/H1/H2/J1	89-93	F
KDX 200 E5/E6	93-94	F
KX 250 G1/H1/H2/J1	89-93	F
KDX 250 SR	91	F
KLF 300 C1-C16	89-04	F
KLF 400 B1-B7	93-99	F
KX 500 E1-E5	89-93	F

SUZUKI

TS 125 RK/RL/RM/RN	90-96	F
RM 125/250 H/J/K/L	87-95	F
TS 200 RK/RL/RM/RN	89-94	F
RMX 250 K/M/N/P/R/S	89-95	F
DR 350 SL/SM/SN/SP	91-97	F
LT-F 300 FK2	02	F
LT-A 500 FY/FK1	00-01	F
LT-F 500 FW/FX/FY	98-02	F

YAMAHA

YZ 125 W/A/B/D/E/F	89-97	F
DT 200 WR (3XP)		F
WR 200 D/E/F	92-94	F
DT 230	91-98	F
TT 250 R	96	F
WR 250 ZD/ZE/ZF	91-97	F
YZ 250 D/E/F/G/H/J	92-97	F
YZ 250 W/WRW	89	F
YZ 250 A/WRA/B	90-91	F
YFZ 450 S	04	F
WR 500 ZD	92	F
XTZ 750	89-95	F

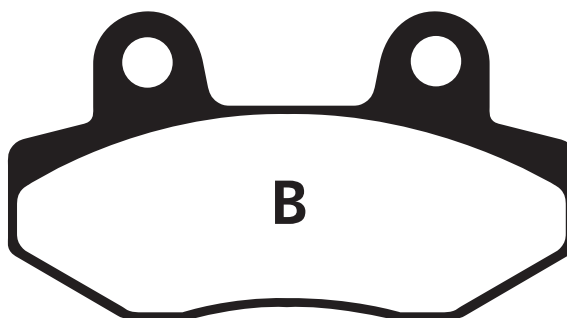
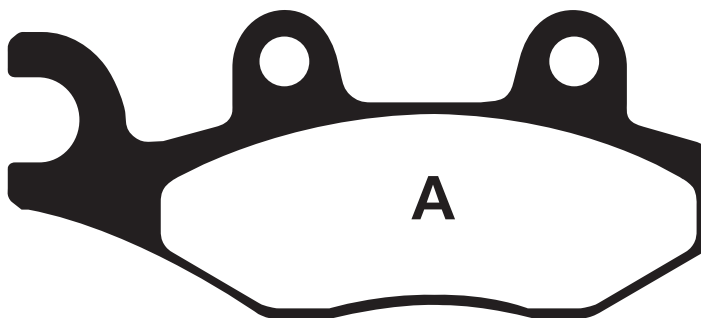

O-236

FA236

70 x 55.5 x 8.3mm

TRIUMPH

T595 Daytona	97	F
Daytona 600	03-04	F
Speedfour 600	02-04	F
TT 600	00-03	F
Daytona 750	92	F
Daytona 900	93-96	F
Trophy 900	92	F
Speed Triple	94-01	F
Daytona 1000	92	F
Daytona 1200	93-98	F
Trophy 1200	93-01	F
Rocket 111 (2300cc)	04	F
Sprint	94-98	F

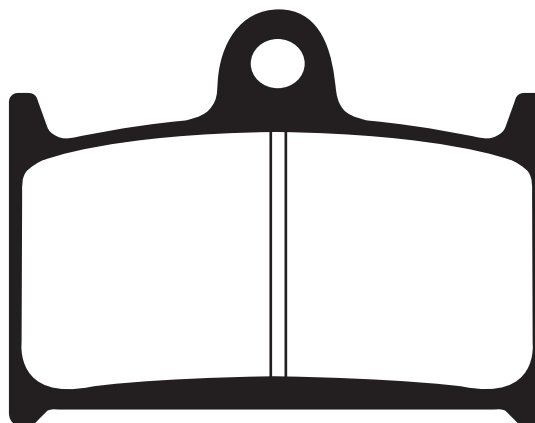

O-237 FA137

47 x 45.1 x 7.5mm

ARTIC CAT

DVX 400 | 04 | R

KAWASAKI

KSF 400 A1/A2 | 03-04 | R

SUZUKI

LT 250 RH/RJ/RK/RL | 87-90 | R

LT-Z 400 K3/K4 | 03-04 | R

LT 500 RL | 90 | R

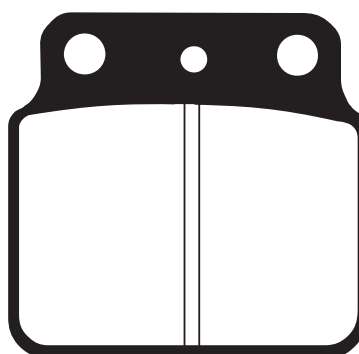

O-240 FA40

A > 41 x 21 mm

B > 41 x 11 mm

HONDA

FL 250 Odyssey | 77-84 | F

POLARIS

Scrambler (3 wheeler) | 85-86 | R

Cyclone 250 X | 87 | R

Trail Boss (2x4) | 85-87 | R

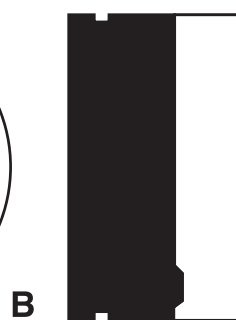
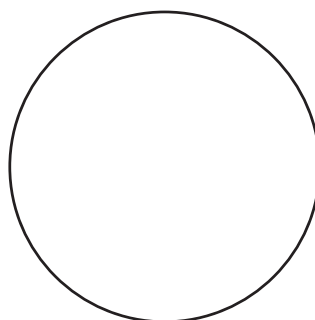

O-244 FA244

75 x 55 x 8.7mm

APRILIA

RS 250 | 98-02 | F

ETV 1000 Caponord | 01-02 | F

RSV 1000 All Models | 98-99 | F

SL 1000 Falco | 00-04 | F

RST Futura 1000 | 01-04 | F

CAGIVA

Raptor/V-Raptor 650/1000 | 00-04 | F

HONDA

CB 400 SF (F3V) | 97 | F

HUSQVARNA

SM 400/450/570/610 | 00-03 | F

SM 610/TE 610 E-LT | 98-99 | F

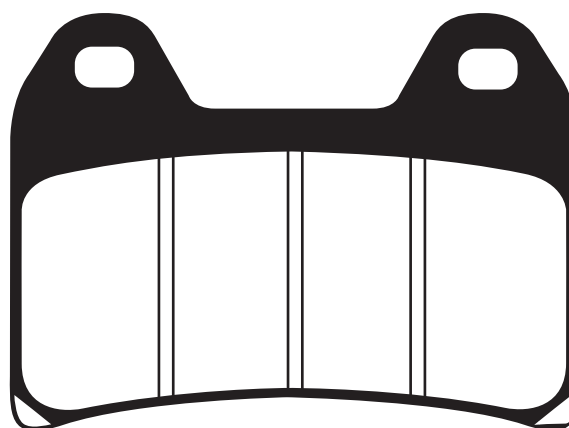

Continúa en página siguiente.

O-244 CONT.

DUCATI

400 Monster/Dark	00-04	F
600 Monster	00-01	F
620/IE/SIE Monster	02-04	F
Monster 620 Dark	03-04	F
748 Racing/SPS	98	F
748 Biposto	99	F
748 SPS	99	F
748 Testa Bassa	01	F
750 Supersport	99	F
750 Sport	01-02	F
750 Monster	00-01	F
Monster 800/IE/SIE	03-04	F
800 Sport	03	F
800 Supersport	03-04	F
900 Supersport	98-99	F
900 Sport	02	F
900 IE Monster	00-01	F
900 MH Evoluzione	00-01	F
916 SPS	98	F
Monster S4	01-03	F
STS 3 (992)	04	F
Multi Strada 1000 DS	03-04	F
1000 Supersport	03-04	F

MOTO GUZZI

Sport VII	99-00	F
California EV/Special	01	F
V 1100 Brevia	04	F

SUZUKI

GSX 400 X Impulse	99	F
GSX 400 FSV	00	F
GSX 1200 FSW/FSX	98-99	F

YAMAHA

XJR 400	95	F
FZ 400	96	F
XT 660 X Supermoto	04	F
XJR 1300	98	F

O-245

FA245

94 x 37.3 x 8mm

APRILIA

RST 1000 Futura	01-04	R
-----------------	-------	---

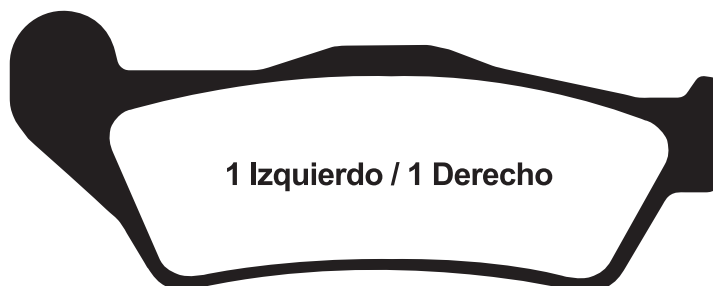

O-246

FA146

58.8 x 57.1 x 9mm

SUZUKI

GSX 400 FJ/FK/FAK	88-90	F
GSX 600 FJ/FK/FL/FM	88-97	F
GSX 750 FK/FL/FM	89-97	F
VX 800 L/M/N/P/R	90-96	F
GSX 1100 FJ/FL/FM	88-93	F
GSX 1100 GM/GN	91-94	R
GV 1400 GDG/GDG	86-88	F

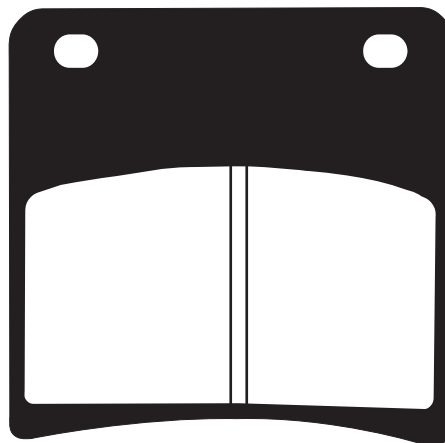

O-249**FA249/249-2****FA249 HONDA**

CB 1300 FW/FX/FY | 98-00 | F

KAWASAKI

ZX-7RR | 96-99 | F

YAMAHA

YZF-R7 750 | | F

FA249-2

Behringer Endurance Caliper

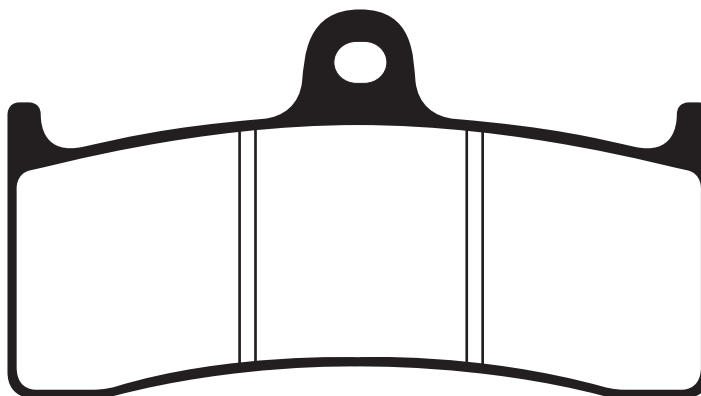
FA249 > 91.6x51.5x8.5mm**FA249-2** > 91.6x51.5x12mm**O-260****FA260**

35 x 49 x 7mm

Equivalente a **O-125****VESPA ROAD**

ET2 50cc | 97-05 | F

LX 50 | 05-06 | F

ET4 150cc | 99-05 | F

LX 150 | 05-06 | F

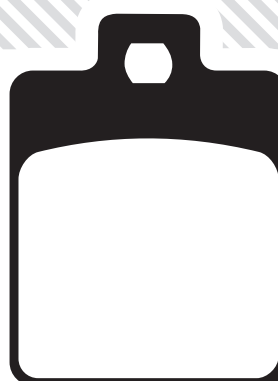
**O-281****FA281**

115.6x41 x9.3mm

GARELLI

Skynet 250/400 | 02 | F

HONDA

FES 125 W/Y/1/2/3 | 98-04 | F

FES 150 W/Y/1/2/3 | 98-04 | F

FES 250 W/X/Y/1/2 | 98-04 | F

NSS 250 Y/AY/A1 | 00-04 | F

FJS 400 2 (NF01) | 01-02 | F

600 Silverwing | 01-04 | F

PEUGEOT

SV 250 | 01-02 | F

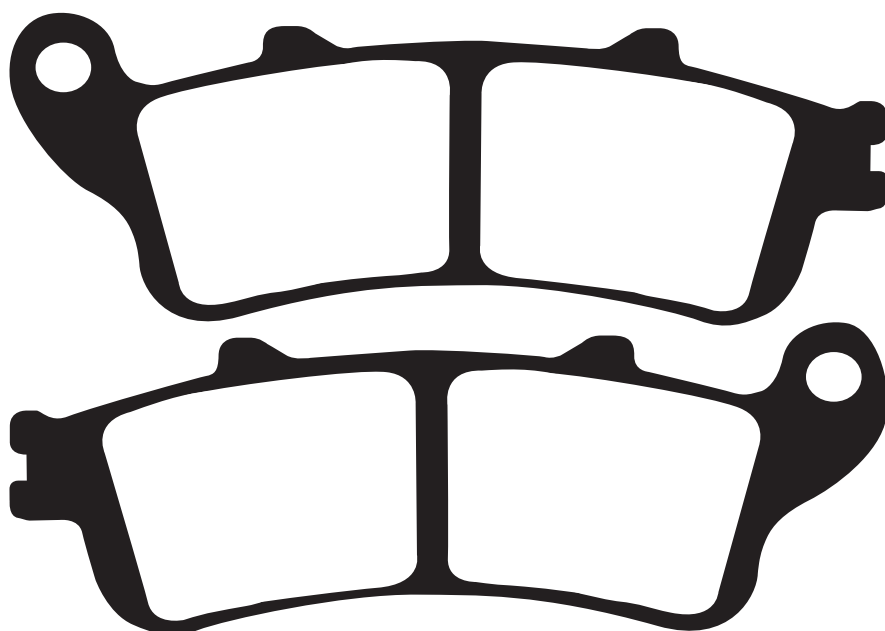

O-294 FA294HH

81 x 45.9 x 7.7mm

BMW

R 1100 S	00-03	F
R 1150 R	01-03	F
R 1200 CL	03	F
R 1150 GS	03	F
R 850 R	03	F
K 1200 LT	00-03	F

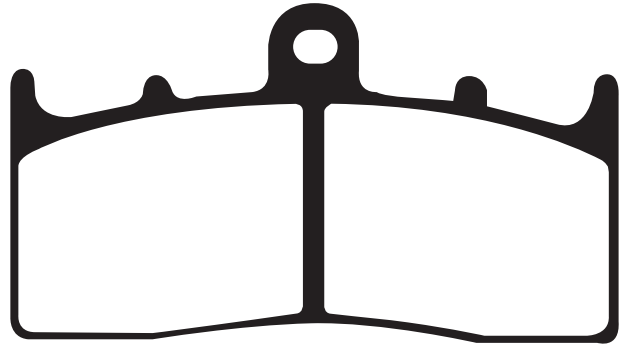

O-296 FA296HH

74.75 x 55.4 x 7.6mm
(No shim fitted)

HONDA

CB 400 SFX/SFY	99-03	F
CBR 600 FX/FY	99-00	F
CBR 600 F1/F2	01-02	F
CBR 600 F3/F4	03-04	F
CBR 600 RR3/RR4	03-04	F
CB 1300 F3/F13	03-04	F

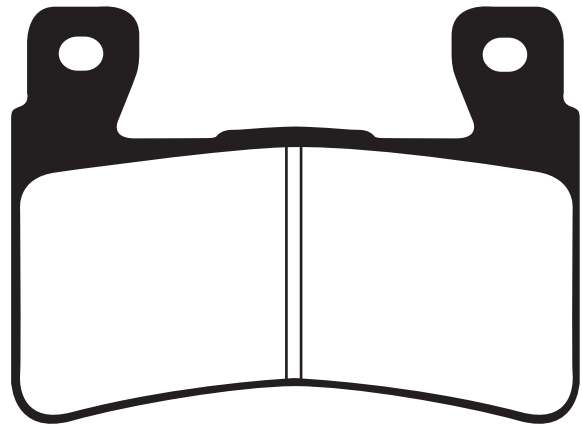

O-298 FA298

50.96 x 53.4 x 9.5 mm

APRILIA

Scarabeo 50 Ditech 2T SCA00	01-04	R
SR 50 Ditech LC RLD100	02-04	R
SR 50 Street LC TE00/TEA00	03-08	R
SR 50 R/Factory LC VFB00/VFD00	04-09	R
SR 50 H20 Ditech RLA1/RLB1	00-03	R
SR 50 R SBK Aprilia (Replica) LC	10-11	R
Atlantic 125/200/250	03-06	R
Atlantic 125	03-08	R
Atlantic 125	10	R
RS125 Radial Caliper Model	06-11	R
Scarabeo 125/150/200	99-02	R
Scarabeo 125/200	03	R
Scarabeo 125/150/250 GT	04-06	R
Scarabeo 125/200	07-09	R
Sport City 125	04-08	R
Sport City Cube 125	08-11	R
Atlantic 200	03-05	R
Sport City 200	04-08	R
Sport City Cube 200	08-10	R
Atlantic 250 ie	06-08	R
Atlantic 250	03-05	R
Leonardo 250 S T/ S P	00-04	R

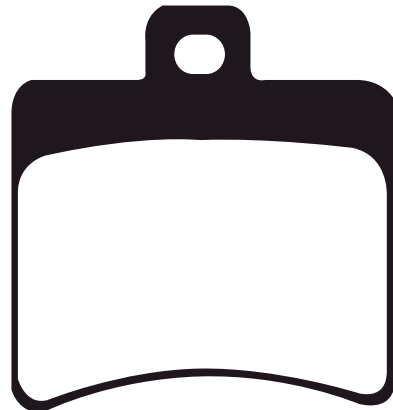

Continúa en página siguiente.

O-298 CONT.

50.96 x 53.4 x 9.5 mm

APRILIA

Scarabeo 250	06	R
Scarabeo 250 ie	07-10	R
Sport City 250 ie	06-08	R
Sport City Cube 250	08-09	R
Atlantic 300	10-11	R
Sport Cube 300 Blackline	11	R
Leonardo 300	05-06	R
Sport City Cube 300	08-11	R
Atlantic S print 400	05-08	R
Scarabeo 400 ie	07-08	R
Atlantic 500	02-04	R
Atlantic S print 500	05-08	R
Scarabeo 500	03-06	R
Scarabeo 500 ie	07-09	R
Scarabeo 500 Light	07	R

ZANELLA

Keeway 200

BETA

Eikon 125/150 00-06 R

DERBI

Boulevard S 125	07	R
Rambla 125	08-10	R
Rambla 250 i	08-09	R
Rambla 300 i	10	R

KEEWAY

R K V 125 10-11 R

MALAGUTI

Madison T125/150/R180/S250	99-03	R
Madison 125-3	06-09	R
F 18 Warrior 125/150	00-03	R
Phantom Max 125/200	04-08	R
R 125 Madison	03-07	R
Madison S 200	04	R
Madison 250 ie 3	06-10	R
Password 250	05-11	R
Phantom Max 250	04-08	R
250 Madison	04-07	R
Scarabeo 300 S	09-10	R
Madison K 400	02-06	R
Spidermax R S 500	04-11	R
Spidermax G T 500	04-10	R

O-299 FA299

92.9 x 65.15 x 7.5 mm

HARLEY DAVIDSON

All Models		F&R
Softail Springer	00-03	R
Heritage Springer	00-03	R
V-Rod	02-03	F&R

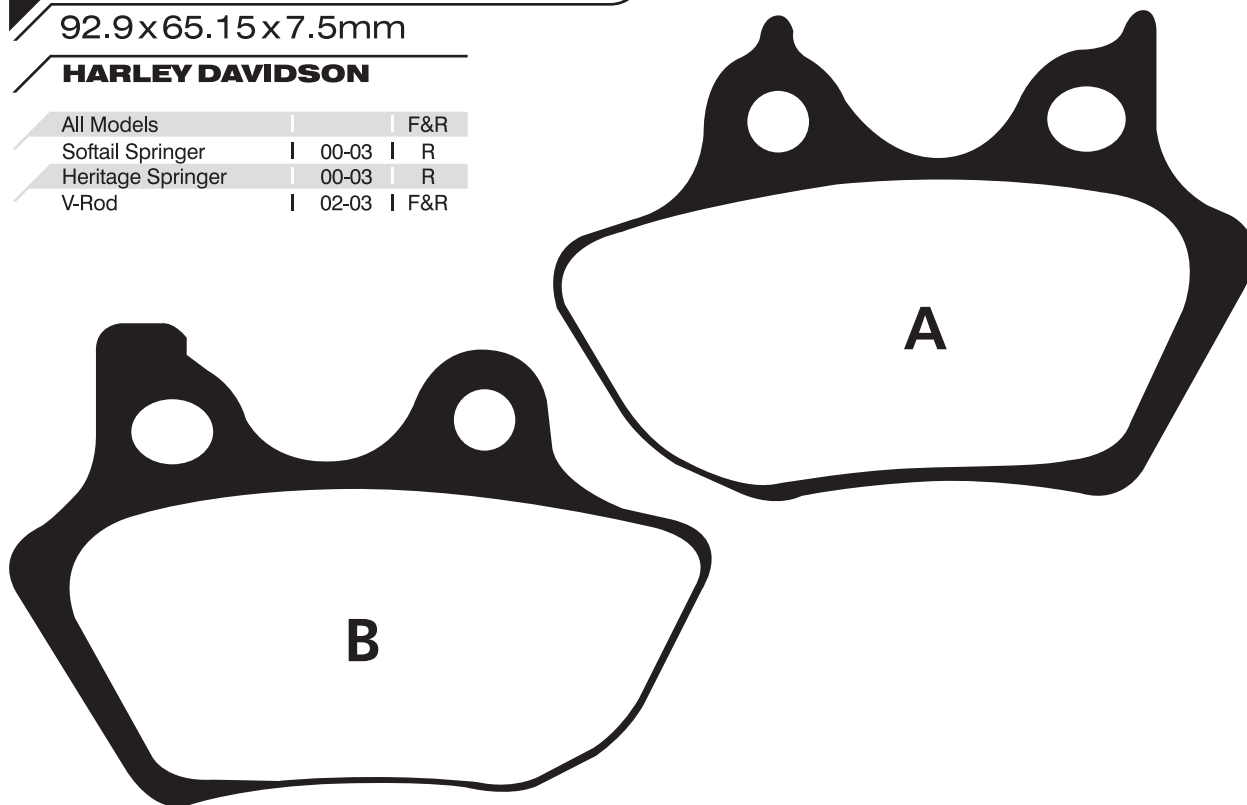

O-301**FA251****A** > 96.7 x 42 x 8.5mm**B** > 77.3 x 42 x 8.5mm**SCORPA**

TY-S 125 F Trials	03-04	R
250 Trial	00-04	R
SY 250 Long Ride	04	R

MONTESA/HONDA

Honda 315 R	01-04	R
-------------	-------	---

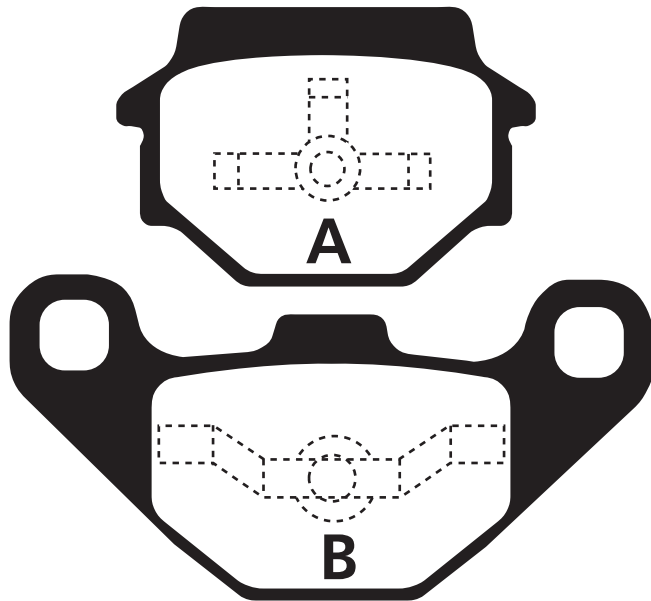
**O-302****FA252**

55.7 x 55 x 9mm

YAMAHA

TZR 125 R / 250 R	92-94	F
FZR 400 RR (4DX)	92	F
FZS 600 Fazer	98-03	F
YZF 600 R Thundercat	96-03	F
TDM 900 P/R/S	02-04	F
FZS 1000 Fazer	01-04	F
YZF 1000 R1	98-03	F
BT 1100 P/R Bulldog	02-04	F
XJR 1300/1300 SP	99-04	F
FJR 1300 N/P	01-02	F
XV 1700 PCR	03-04	F

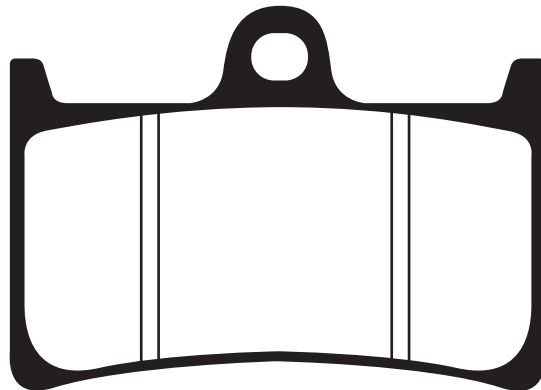
**O-303****FA254**

59.7 x 57 x 8mm

KAWASAKI

ZX-7RR (ZX750 N1/N2)	96-99	R
----------------------	-------	---

HONDA

CB 400 SFX/SFY/SF1	99-03	F
X4 CB 1300 DCV	97	R
CB 1300 FW/FX/FY/F1	98-01	R

SUZUKI

GSXR 600/750 K4	04	R
GSF 1200 SSK1/ZK1	02	R

Agujero de anclaje
Derecha a izquierda 7.3 mm
Arriba a abajo 6.2 mm

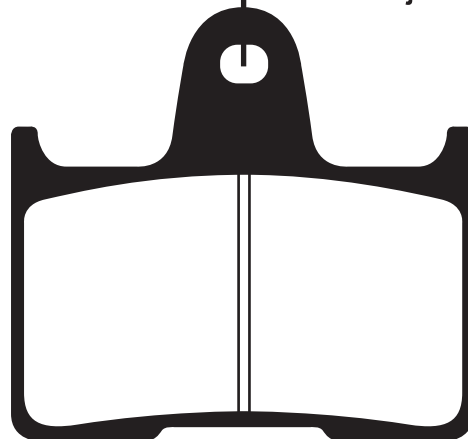

O-304 FA257-2

41.1 x 43 x 5.3mm

HONDA

Tact 50		F
SK 50 MM-II/MM-YD		

SYM

Super Fancy 50		96-02		F
City Hopper 50		99-02		F
Cinderella 50/100		99-00		F

GARELLI

Panther 125/150/250		02		F
---------------------	--	----	--	---



O-305 FA267

51.85 x 59.75 x 8.9mm

YAMAHA

YZF 1000 R1		98-00		R
YZF R7 750 "OWO2"		99-00		R

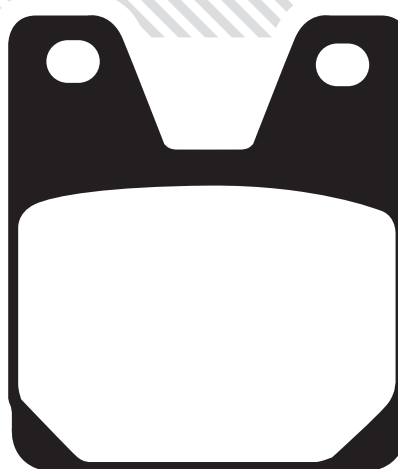

O-307 FA307

A > 82.08 x 40.85 x 9.46mm

B > 62.03 x 40.8 x 9.46mm

YAMAHA

YFM 400 FAM/FAN		00-01		R
YFM 400 AM/AN		00-01		R
YFM 400 FAHM/MC		00-02		R
YFM 450 Fair Kodiak		03		R
YFM 450 FAR/FAS		03-04		R

BOMBARDIER

Traxter 500 "4x4" (All m.)		01-03		F(Left)&R
DS 650 (All Models)		00-03		F(Left)&R
Quest 500/650 (All m.)		02-03		F(Left)&R
Outlander 400 (4x4)		03		F(Left)&R

CANNONDALE

All quads		01-04		F(Left)&R
-----------	--	-------	--	-----------

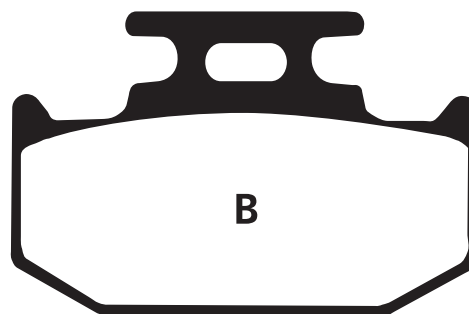
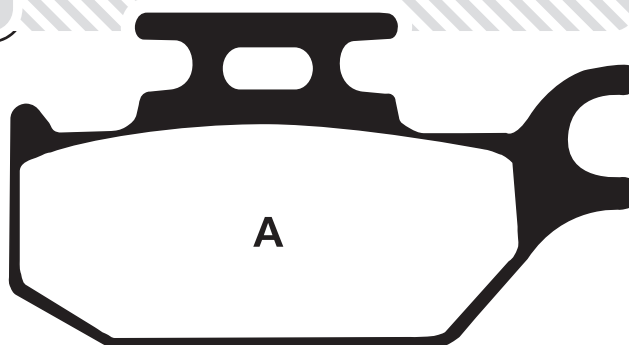

0-308**FA366**

69.8 x 46.7 x 13.05mm

SUZUKI

DR 50	02-03	R
VL 1500 K2/K3		

APRILIA

TX 125
TX 300
TX 311/312

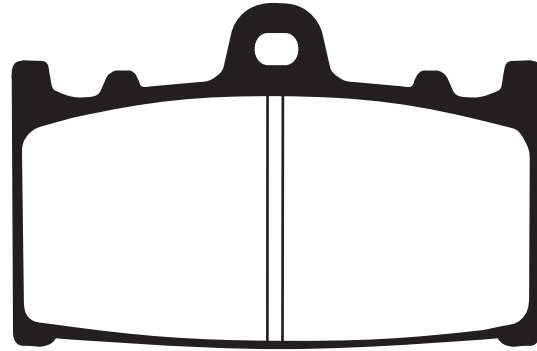
**0-309****FA372R****A** > 37 x 55.5 x 10.94mm**B** > 85 x 35 x 8.7mm**SUZUKI**

LT-A 500 FK3 Vinson	03-04	R
---------------------	-------	---

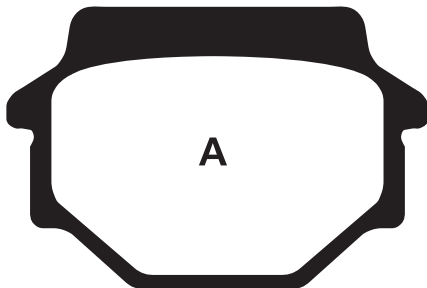
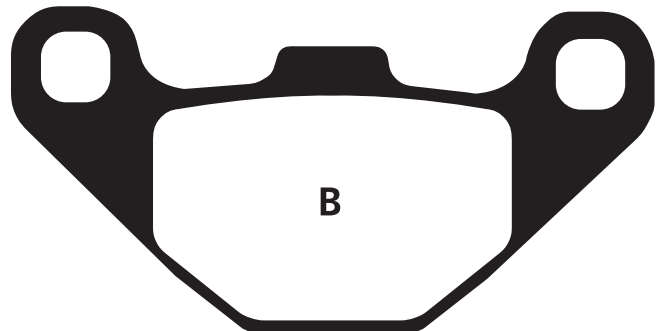
**A****B****0-310****FA94**

60 x 63 x 13mm

HARLEY DAVIDSON

FXD/FXDL/FXDWG	91-99	F
FXST/FXSTB/FXSTC	84-99	F
FX/FXE/FXEF/FXWG	84-86	F
XL/XLH/XLCH/XLS	84-99	F
FXR/FXRS/FXRT	94-97	F
FLT/FLHT/FLHTCI	84-99	F
FLHR/FLHRCI	94-99	F
FXSTS/FXSTI	00-04	F
FLSTS H.Springer	00-03	F

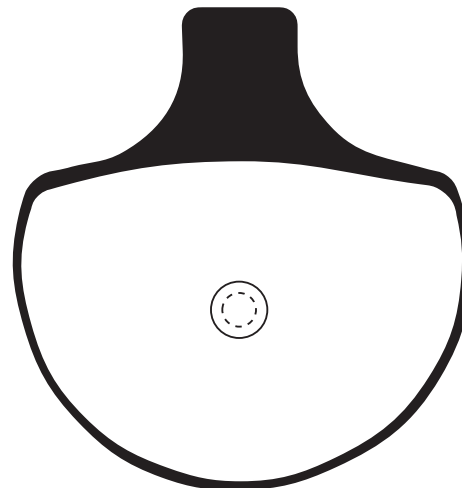

O-311

FA95/95-2

ATK

500/600 Supermotard	02-03	F
500/600 DR	00-03	F

CAGIVA

S 440	03	F
-------	----	---

DUCATI

Supersport 400	93-97	F
400 Monster	95-97	F
600 Monster	93-99	F
600 Monster Dark	98-99	F
748 SP / Biposto	95-98	F
750 Supersport	91-98	F
600 Supersport	91-97	F
750 Monster	96-97	F
851 Superbike / Biposto	89-92	F
888 SP4/SP5	92-93	F
888 Superbike Strada	94-95	F
900 Supersport	89-90	F
900 Monster	93-99	F
907 IE	90-93	F
916 SP	94-96	F
916 Biposto-Senna	94-98	F
916 Racing	98	F
996 Racing	99	F

HUSQVARNA

SM 450/570/610	01-03	F
----------------	-------	---

KTM

SMC 660	02-03	F
640 LC4 Supermoto	02-03	F

FA 95 > 69.2 x 47 x 8.2mm

FA 95-2 > 69.2 x 47 x 10mm

LAVERDA

650 Sport	94-95	F
668 Diamante	96-98	F
750 S Formula/Sport	98-00	F
750 Strike Bifaro	98-00	F
750 S Carenta	98-00	F

MOTO GUZZI

Daytona 1000	92-95	F
Daytona 100 RS	97-98	F
V10 Centauro	97-99	F
California EVII	97-01	F
Sport 1100	94-99	F
Sport Corsa 1100	98-99	F

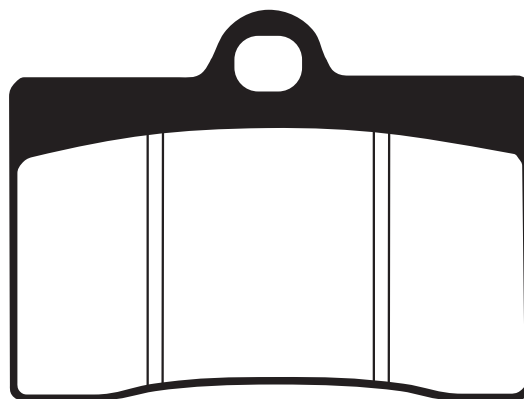

O-312

FA123

74.8x54x10mm

YAMAHA

FZR 250	87	F
TZR 250	87-92	F
TDR 250	88-92	F
TZR 250	87	F
FZR 400	88-89	F
SRX 400	90-96	F
SRX 600	90-91	F
FZ 750	89-91	F
TDM 850	91-95	F
TRX 850	96-99	F
FZR 1000	87-88	F
FJ 1200	88-95	F
XJR 1200	95-98	F
XVZ 1300 TF	99-01	F
XV 1600	99-04	F

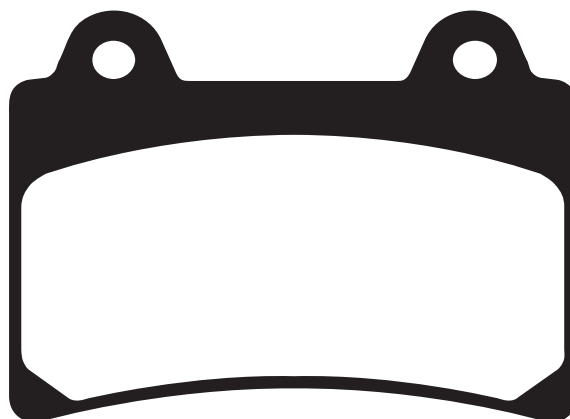

O-314 FA314R

90.3 x 41.05 x 8.2mm

POLARIS

Magnum 325/500	02-03	R
Xpedition 325	02	R
Magnum 330 (2x4)	03-04	R
Magnum 330 (4x4)	03-04	R
Sportman 400	03	R
Sportman 400	03-04	R
ATV Pro 500 4x4	02	R
Magnum 500 HDS	02-03	R
Magnum 500 (2x4/4x4)	02	R
Sportman 500 HP	03-04	R
Sportman 600 (4x4)	03-04	R
Sportman 700 (4x4)	02-04	R

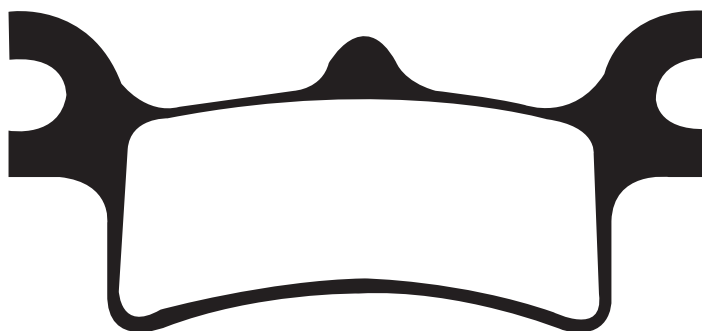

O-317 FA317X

A > 82.08 x 40.85 x 9.46mm

B > 62.03 x 40.8 x 9.46mm

BOMBARDIER

Traxter 500 4x4 (All m.)	01-03	F (Right)
DS 650 (All models)	00-03	F (Right)
Quest 500/650 (All m.)	02-03	F (Right)
Outlander 400 4x4	03	F (Right)

SUZUKI

LT-A 500 KK2 Vision	02	R
LT-F 500 FK3/FK4	03-04	R

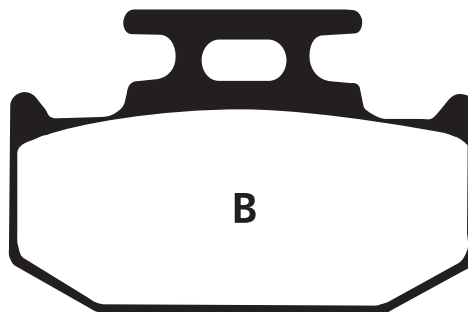
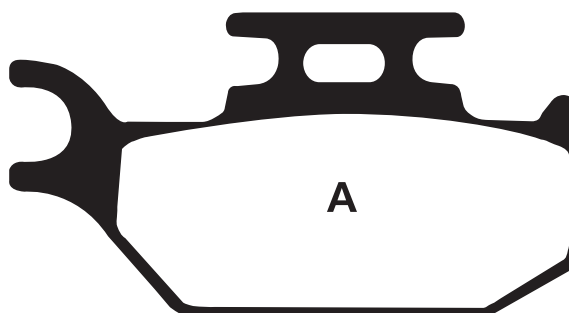

O-319 FA319

99.84 x 38.52 x 11.8mm

YAMAHA

Yamaha TDM 900	R
Yamaha FJR 1300 (Trasera)	R

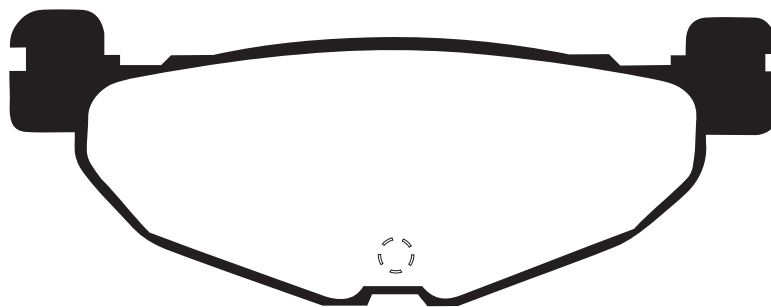

O-335 FA335HH

72.25 x 51.45 x 8.55mm

BMW

R 850 R T	06	F
R 1100 S (Non ABS)	12/00-03	F
R 1150 GS (EVO-R21/0415/0495)	11/01-03	F
R 1150 GS Adventure	07/01-06	F
R 1150 RT (Integral ABS)	00-06	F
K 1200 RS/R/S	01-05	F
K 1200 GT (K41)	03-08	F
K 1200 GT (K44)	06-08	F (left)
K 1200 S (K40)	05-08	F
R 1200 GS (K25/0307/Cast/Spoke wheel)	02-11/07	F
R 1200 GS Adventure (K25/0382/Spoke wheel)	05-11/07	F
R 1200 GS Adventure (Spoke wheel)	10-11	F
R 1200 GS Adventure/M (K25/0380/Spoke wheel)	06-09	F
R 1200 GS/M (K25/0303/Cast wheel)	06-09	F
R 1200 GS (Cast wheel)	10-11	F
R 1200 GS Adventure (30 years GS)	11	F
R 1200 GS Triple Back (Spoke wheel)	11	F



R 1200 GS 30 years GS	11	F
R 1200 RT K26/0368 Brembo Caliper	05-09	F
R1200 RT	10-11	F
R 1200 RT-SE	10-11	F
R1200 ST K28/0328	03-08	F
R 1200 S K29/0366 Brembo Caliper	06-08	F
HP 2 Megamoto	07-09	F
HP 2 Megamoto (K25)	07-10	F
K 1300 GT	09-11	F
K 1300 GT EE	10-11	F
K 1300 GT SE	10-11	F
K 1300 S	09-11	F

O-342 FA342SV

A > 26.1 x 119.55 x 7.1mm

B > 35.6 x 94.54 x 7.8mm

SUZUKI

LT-V 700 FK4/FK5	04-05	F (Left)
------------------	-------	----------

KAWASAKI

KFX 450	07	F (Left)
KVF650 A1/A2/B2	02-03	F (Left)
KVF 650 D1/D6F/D7F	05-07	F (Left)
KVF 650 E1/E6F/E7F	05-07	F (Left)
KVF 700 A1/A2/A6F	04-06	F (Left)
KVF 700 A1/A2/A6F	04-06	F (Left)
KVF 700 D1/D6F	05-06	F (Left)
KSV 700 B1/B2/B6F	04-06	F (Left)

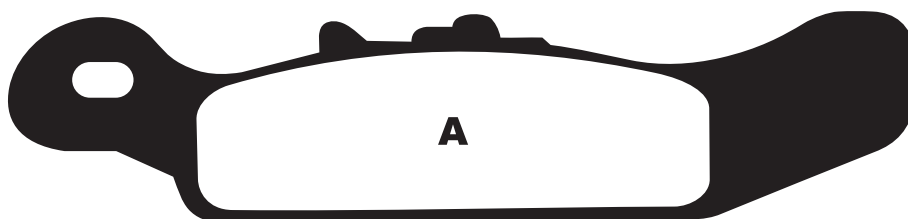
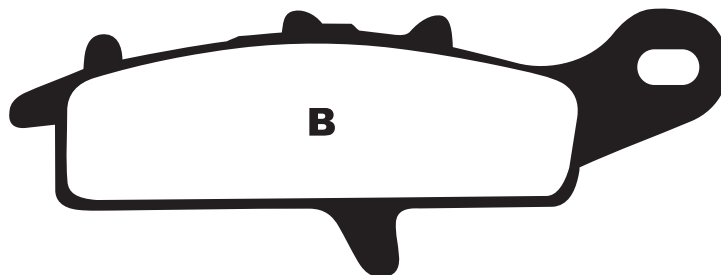

O-344 FA344X

65.5 x 44.75 x 11.65mm

YAMAHA

YFM 660 FAP/FHAP	02-04	R
YFM 660 FAHDV/W	06-07	R



O-346 FA346X

60 x 44.8 x 11mm

HONDA

CR 125 R2/R3/R4	02-04	R
CR 250 R2/R3/R4	02-04	R
CRF 250 R4 / XF	04	R
CRF 450 R2/R3/R4	02-04	R
XR 250 SM	04	R
XR 400/440 R	04	R
CRE 125 R Supermotard	02-03	R
CR 230 Easy Trail	04	R
CRF 230 Easy Enduro	04	R

MOTOMEL

Megalli 250	Trasera
-------------	---------

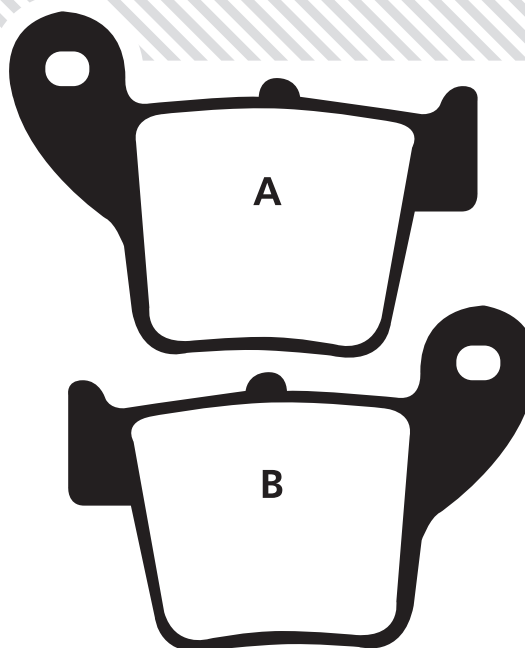

O-349 FA349R

A > 26.1 x 119.55 x 7.1mm

B > 35.6 x 94.54 x 7.8mm

KAWASAKI

KFX 450 R Quad (KSF 450 B8F/B9F/BAF/BBF)	08-11	F (right)
KVF 650 A1/A2 Prairie	02-03	F (right)
KVF 650 D1/D6F/D7F/ D8F/D9F/DAF/DBF Brute Force 4x4	05-11	F (right)
KVF 650 E1/E6F/E7F/ E8F/E9F Brute Force 4x4 Hardwoods Green HD	05-09	F (right)
KVF 700 A1/B1/A2/A6F/ B2/B6F/A7F/A8F 4x4 (Prairie)	04-08	F (right)
KVF 700 D1 Team Green	05	F (right)

SUZUKI

LT-V 700 FK4/FK5 (Twin Peaks)	04-05	F (right)
----------------------------------	-------	-----------

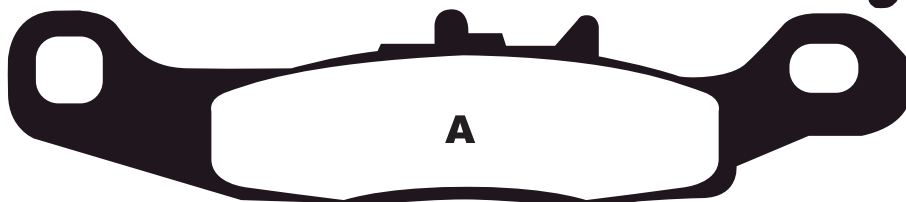
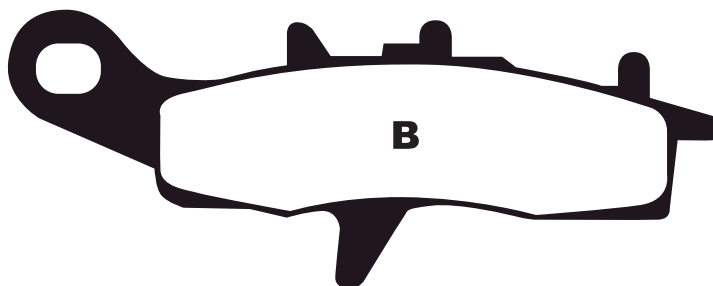

O-363**FA245**

94 x 37.3 x 8mm

APRILIA

RST 1000 Futura | 01-04 | R

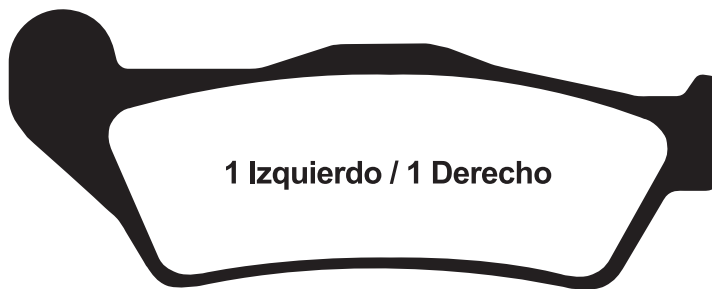
**O-367****FA367X**

66.9 x 36.1 x 10.75mm

KAWASAKI

KX 250 F (KX 250 N1) | 04 | R

YAMAHA

YZ 125 R/S | 03-04 | R

RM-Z 250 K4 | 04 | R

YZ 250 R/S | 03-04 | R

YZ 250 FR/FS | 03-04 | R

WR 250 FR/FS | 03-04 | R

WR 450 FR/FS | 03-04 | R

YZ 450 FR/FS | 03-04 | R

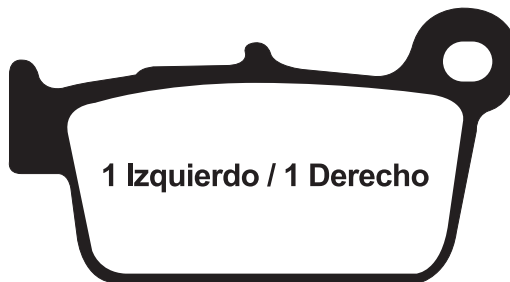
**O-368****FA368****A** > 64 x 41.6 x 10mm**B** > 64 x 41.6 x 11mm**APRILIA**

SXV 4.5 Supermoto | 04 | R

KTM

250/450 SX | 03-04 | R

125/200/525 SX | 04 | R

**O-369****FA369-4HH**

49.2 x 38.6 x 7.75mm

KAWASAKI

ZX-6RR (ZX 600 K1) | 03-04 | F

ZX6R (ZX 636 B1/B2) | 03-04 | F

ZX 10 R (ZX 1000 C1) | 04 | F

ZX 12 R (ZX 1200 B3) | 04 | F

SUZUKI

GSXR 1000 K3 | 03 | F

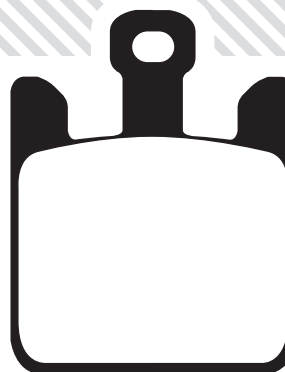

0-376 FA376

91.6x51.5x8.5mm

AMERICAN IRON HORSE

Six piston caliper | 03-04

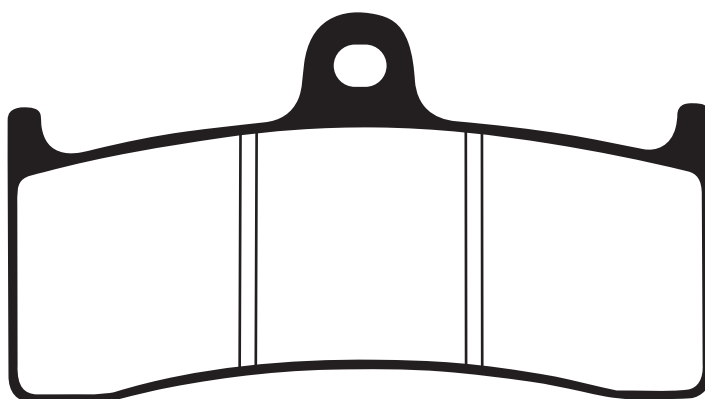

0-379 FA379HH

71.45x49.9x7.76mm

SUZUKI

GSXR 600 K4 | 04 | F

GSXR 750 K4 | 04 | F

GSXR 1000 K4 | 04 | F

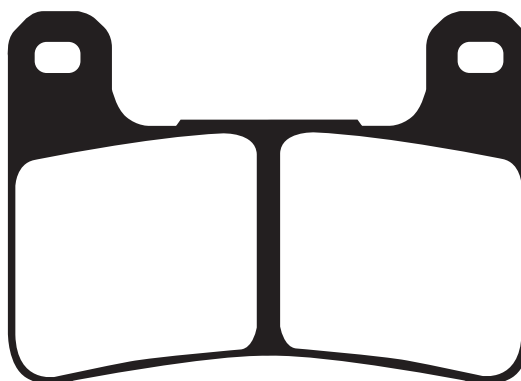

0-380 FA380HH

50.4x69x8.7mm

YAMAHA

YZF-R6 T/V/W | 05-07 | F

YZF R1 | 04-05 | F

YZF R1 LE | 06 | F

YZF 1000 V/W | 06-07 | F

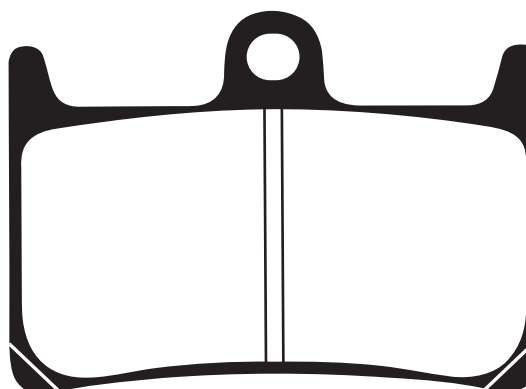

O-381 FA381

103x48x10.9mm

HARLEY DAVIDSON

XL 50 50th Anniversary Sportster	07	F
XL 880 Sportster STD	04-08	F
XL 880C Sportster Custom	04-10	F
XL 883 L (883 Low)	04-10	F
XL 883 R Sportster R	05-09	F
XL 883 R Roadster	10	F
XL 883 N Iron	09-10	F
XL 883 L Superlow	11	F
XL 1200 C Sportster Custom	04-10	F
XL 1200 R Sportster Roadster	04-08	F
XL 1200 L Sportster Low	07-11	F
XL 1200 N Nightster (Spoke wheel)	08-11	F
XL 1200 X Sportster Forty-Eight	10-11	F

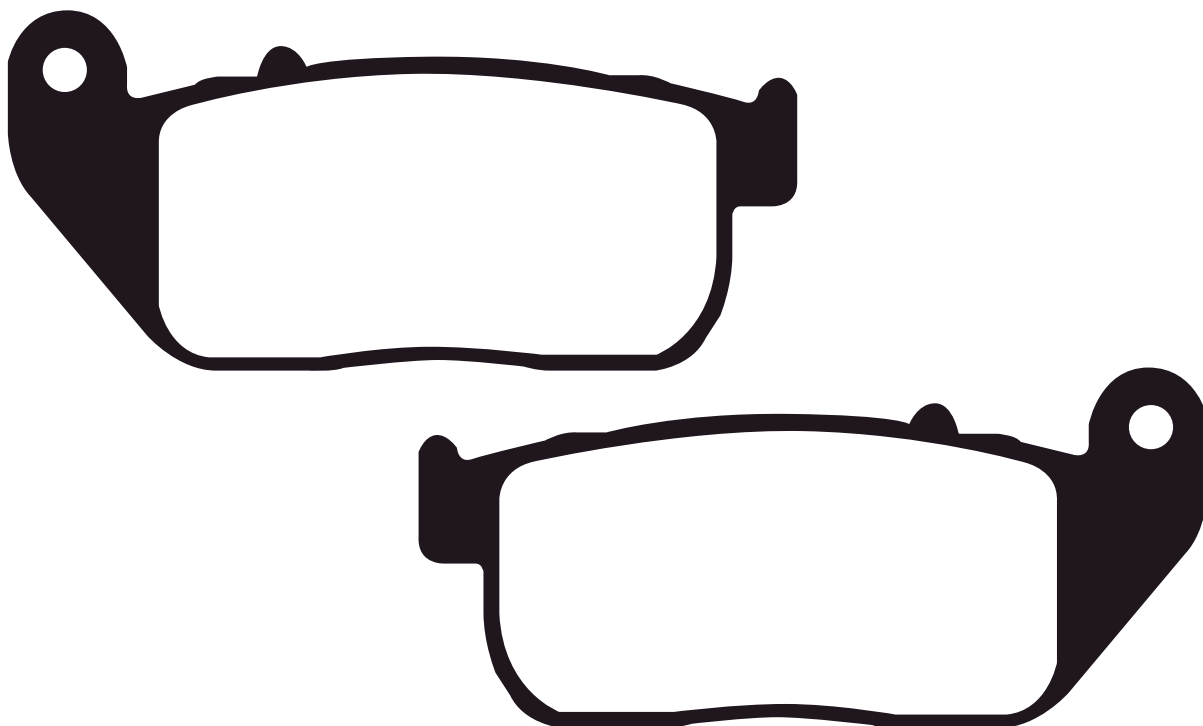

O-387 FA387

87 x 50 x 10.4mm

HARLEY DAVIDSON

XL 50 50th Anniversary Sportster	07	R
XL 880 Sportster STD	04-08	R
XL 880C Sportster Custom	04-10	R
XL 883 L (883 Low)	04-10	R
XL 883 R Sportster R	05-09	R
XL 883 R Roadster	10	R
XL 883 N Iron	09-10	R
XL 883 L Superlow	11	R

Continúa en página siguiente.

O-387 CONT.

87x50x10.4mm

HARLEY DAVIDSON

XL 1200 C Sportster Custom		04-10		R
XL 1200 R Sportster Roadster		04-08		R
XL 1200 L Sportster Low		07-11		R
XL 1200 N Nightster (Spoke wheel)		08-11		R
XL 1200 X Sportster Forty-Eight		10-11		R
XR 1200		08-10		R
XR 1200 X		10-11		R

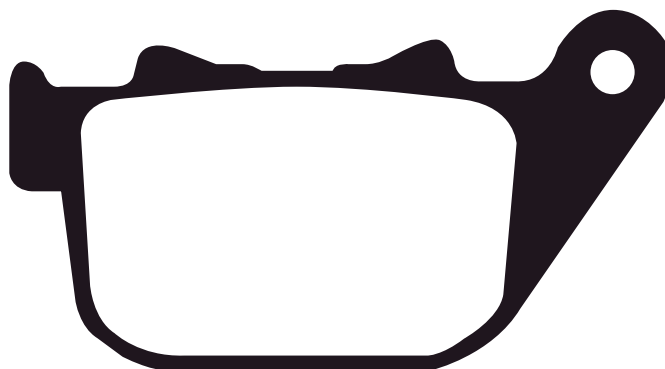
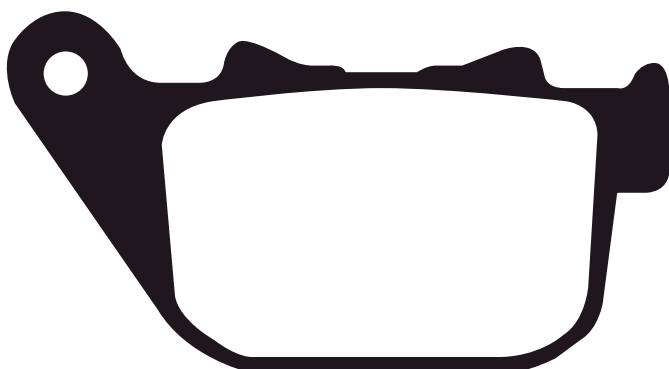

O-390 FA380HH

75x48x8mm

HONDA

CBR 600 RR		05-07		F
CBR 1000 RR		04-07		F



O-400 FA400

A > 97.54x64.2x7.5mm

B > 97.54x64.2x7.5mm

IMPORTANTE
Esta pastilla reemplaza a:
O-299 / FA299

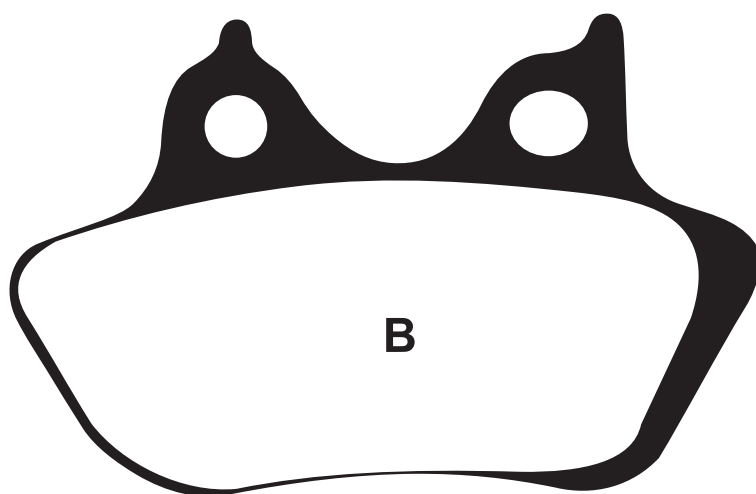
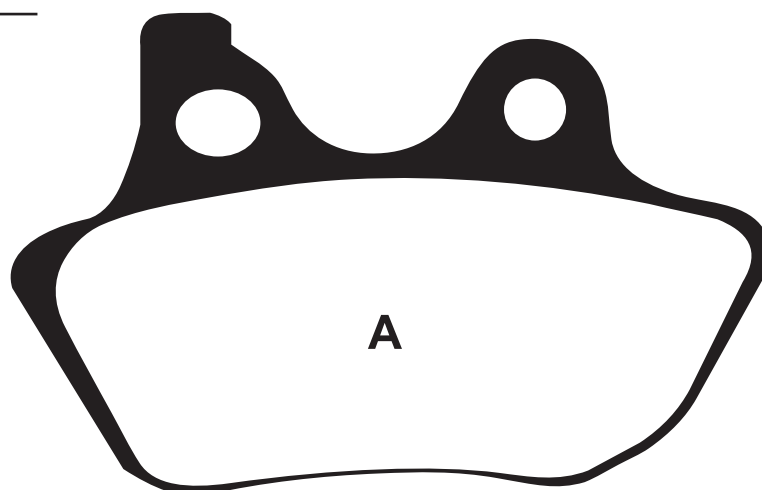

O-401 FA401

A > 99x40.1 x 7.56mm

B > 75.5x37.9x8.26mm

SUZUKI

RM 85 LK5/K5/LK6/LK7/ | 05-11 | R
LK8/K8/LK9/K9/LL0/L0

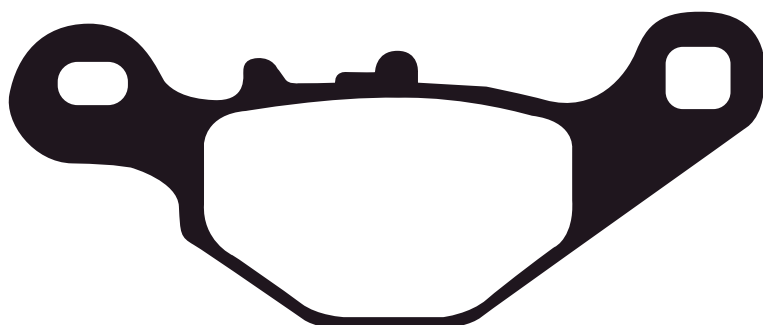
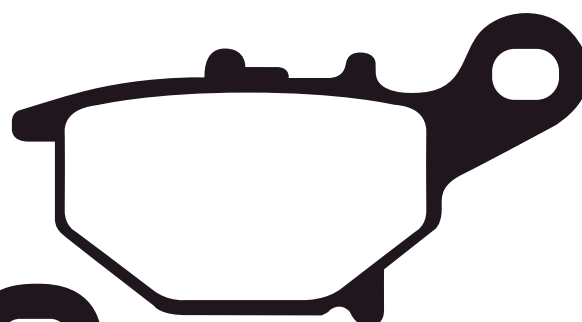

O-407**FA407**

100.10x57.20x8.40mm

BMW

K 100 RS	89-92	F
K 1	88-93	F
K 1100 LT	89-07/93	F
KL 1100 LT	88-89	F
K 1100 RS	92-96	F
K 1200 RS	96-00	F
K 1200 LT	97-10/00	F
R 80 Mystic	94-95	F
R 80 R	91-94	F
R 850 C	97-00	F
R 850 GS	96-00	F
R 850 R	94-02	F
R 850 RT	96-01	F
R 100 Mystic	93-96	F
R 100 R	91-95	F
R 1100 GS	93-99	F
R 1100 R	93-01	F
R 1100 RS	92-01	F
R 1100 S	96-11/00	F
R 1100 RT	94-01	F
R 1150 GS	98-10/01	F
(R21/0415/0495)		
R 1200	00-02	F
R 1200 C	96-02	F

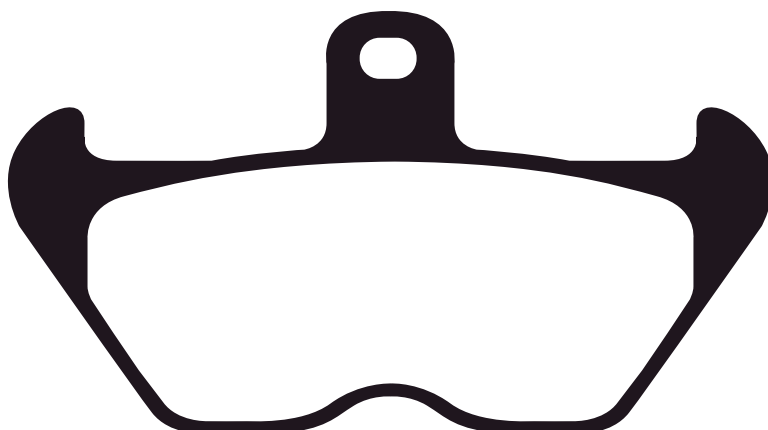
**O-408****FA408**

99.84 x 38.52 x 11.8mm

YAMAHA ROAD BIKE

CP 250 V/W Morphus	06-07	R
YP 400 RS/T/V/W Majesty	05-06	R

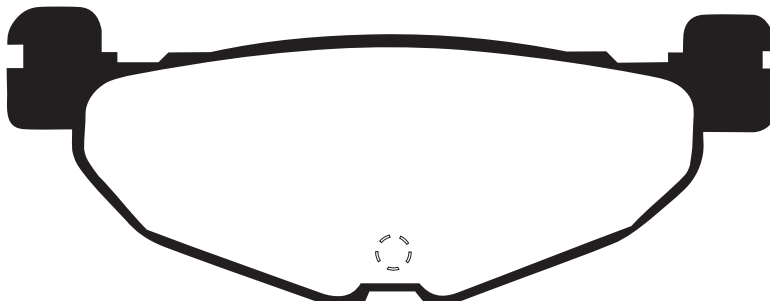
**O-411****FA411**

99.84 x 38.52 x 11.8mm

SUZUKI

AN 400 K3/K4/K5/K6	03-06	R
--------------------	-------	---

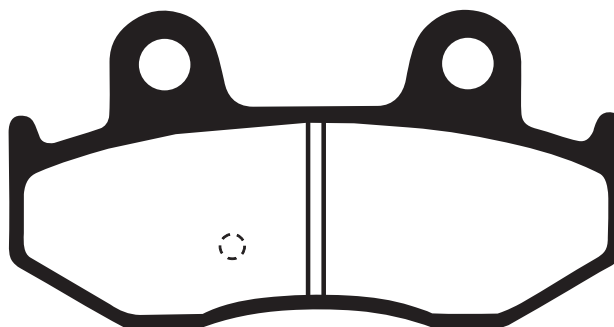

O-412 FA412

87.9x41.1x8.4mm

SUZUKI STREETBIKE

AN 400 K7 Burgman	07	R
AN 650 K3/K4/AK4	03-07	R

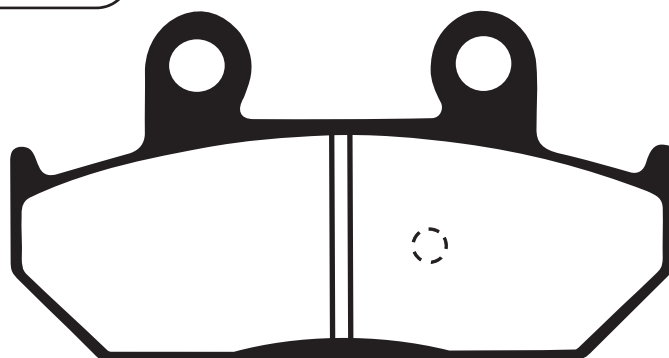

O-413 FA413X

A > 82x40.85x8.2mm

B > 62x40.8x8.6mm

SUZUKI

LT-A 450 XCK7/XK7	07	F (Left)
LT-A 700 XK5/XCK6	05-07	F (Left)

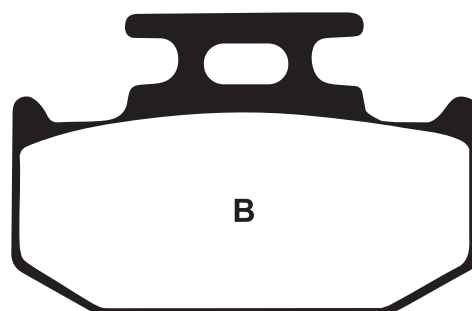
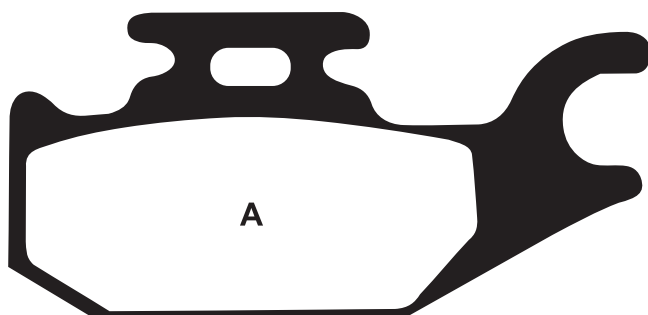

O-414 FA414X

A > 82x40.85x8.2mm

B > 62x40.8x8.6mm

SUZUKI

LT-A 450 XCK7/XK7	07	F (Right)
LT-A 700 XK5/XCK6	05-07	F (Right)

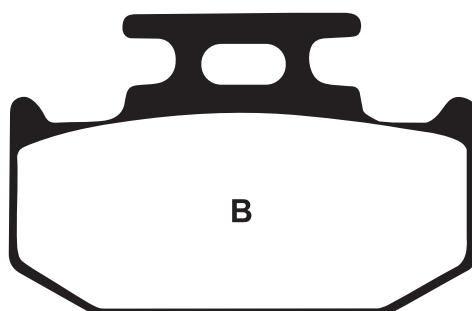
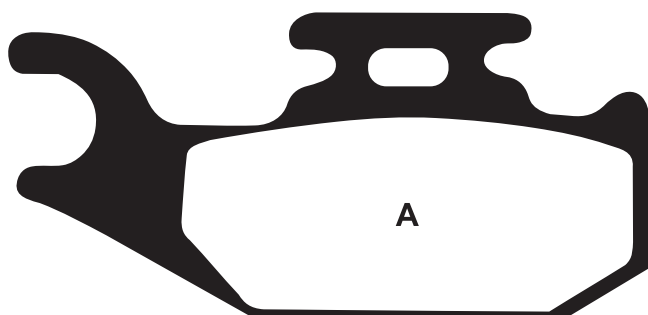

O-417 FA417-4HH

49.85x37.75x7.78mm

KAWASAKI STREET

ZX6R	07	F
Z 1000	07	F
Z 1000 (ABS) ZR 1000	07	F
GTR 1400 Concours	07	F
ZZR 1400	06-07	F
ZZR 1400 ABS	07	F

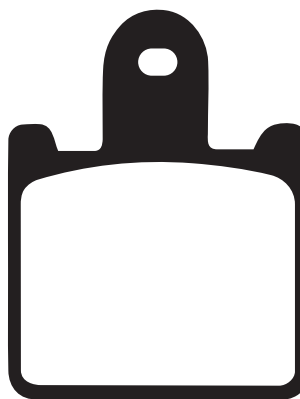

O-424 FA424

91.6x51.5x8.5mm

BUELL

M2 Cyclone	98-00	F
S1 Lightning	98-00	F
S1 White Lightning	98-00	F
S3/S3T Thunderbolt	98-00	F
X1 Lightning	98-00	F

KAWASAKI STREET

ZX-7RR	96-99	F
--------	-------	---

MV

F4 (All Models)	99-06	F
-----------------	-------	---

YAMAHA STREET

YZF 750 R7 OW02	99-01	F
-----------------	-------	---

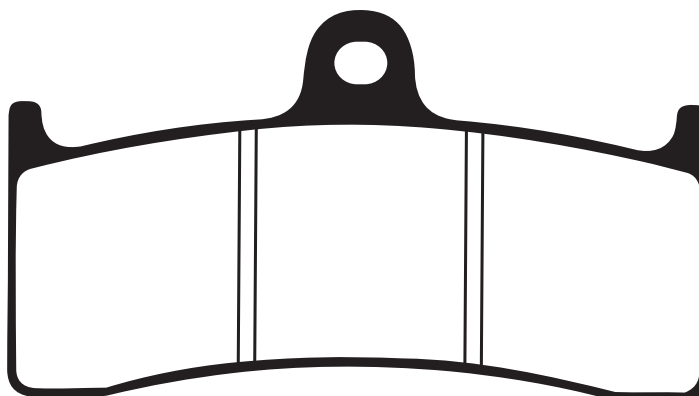

O-428 FA428

A > 82.08x40.85x9.5mm

B > 62.03x40.8x9.5mm

YAMAHA ATV

YXR 450 Rhino 4x4	06	R
YXR 66 FAS/FAT/FAV	04-06	R
YFM 700 RV Raptor	06	R
YXR 660 Sport Rhino	07	R

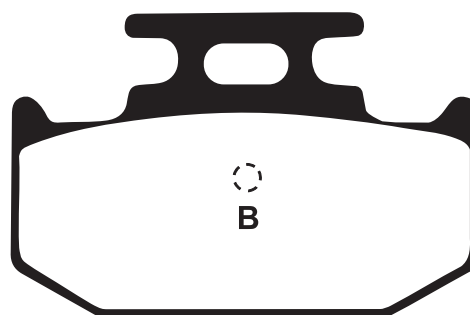
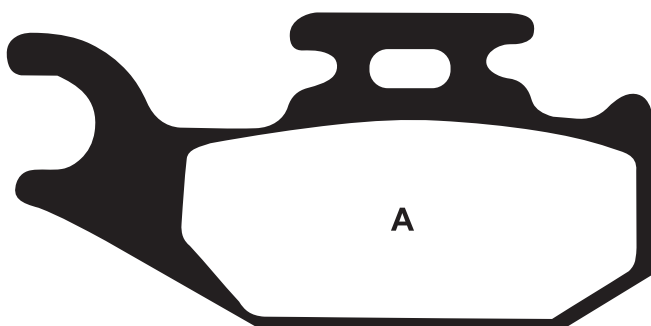

O-434**FA434****A** > 97.54x64.2x8mm**B** > 97.54x64.2x8mm**HARLEY DAVIDSON**

FXST/FXSTI	06-07	R
FXSTB/FXSTBI	06-07	R
FXSTSSE	07	R
FLSTSC/FLSTSCI	06-07	R
FLSTC	07	R

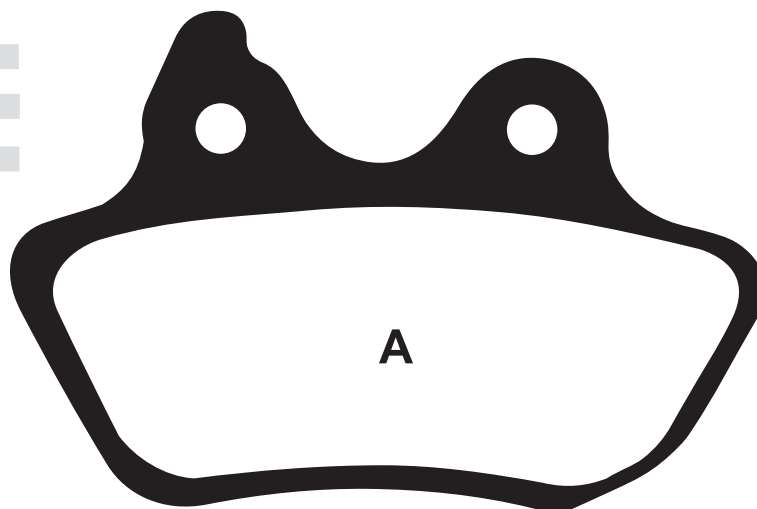
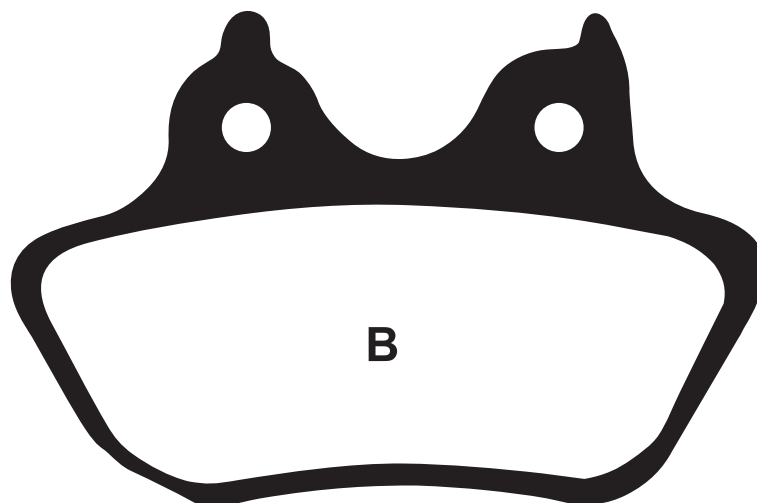
**A****B****O-436****FA436**

77.50x42.50x8.80mm

HONDA STREET

CBR 600 RR	07	R
CBR 1000 RR	06-07	R



O-441 FA441HH

A > 77.3x51.45x8.55mm

B > 77.3x51.45x8.55mm

BMW

K 1200 GT (K44) | 06 | F (Right)

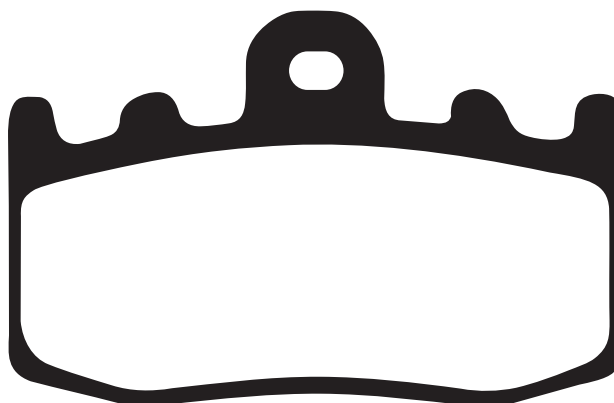
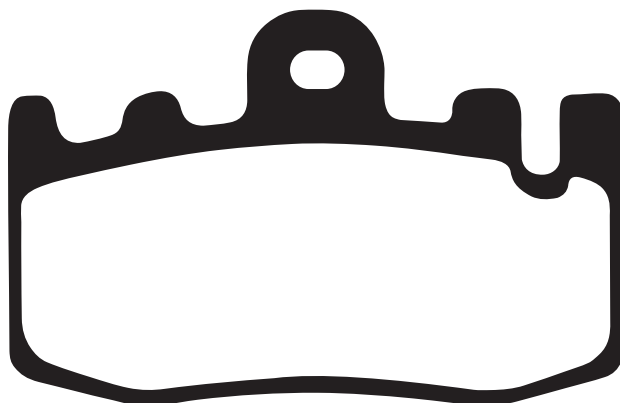

O-465 FA465TT

A > 110.6x34.6x7.42mm

B > 98.7x33.5x7.46mm

DERBI

Cross City 125 | 09-11 | F

Mulhacen 125 (4T) From | 07-09 | F
Ref No.7N001791 Spoke
wheel/single pin fixing

Terra 125 Euro (Single pin | 07-11 | F
pad fixing)

Terra 125 Adventure | 07-11 | F

HONDA H-M

C R E 125 (Baja RR 2T) | 11 | F

RIEJU

MTR 50 Pro Competizione | 11 | F
(Spoke wheel)

Marathon Pro 125 | 11 | F

Competizione

Tango 125 | 11 | F

SCORPA

T-Ride 125 F | 10 | F

T-Ride 250 F (Enduro) | 08-10 | F



O-500

HERO PASSION



O-501

A > 102x43x8mm

B > 86x43x8mm

HONDA

Storm 125

Wave (algunos modelos)

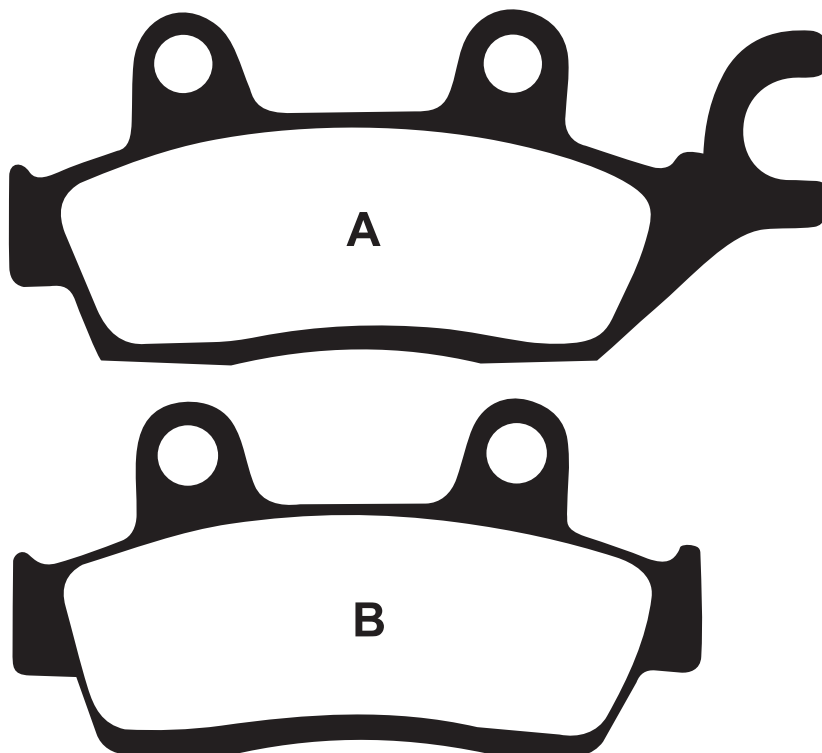

O-502

A > 112x33x8mm

B > 98x35x8mm

HONDA

Wave

Maverick 125

GILERA

Stylo

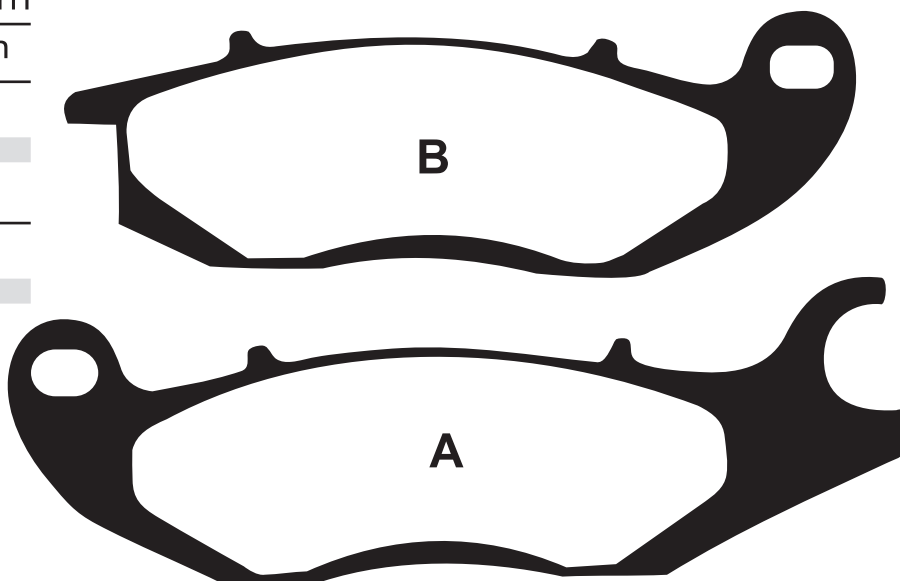

O-503

75x52x7.5mm

ZANELLA

Patagonia

Eagle 250

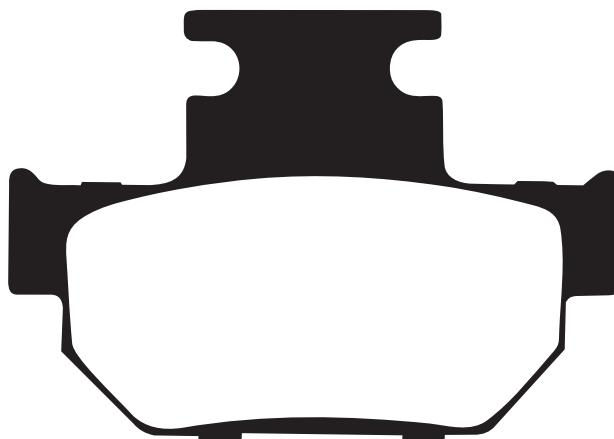

O-504

50x48x9mm

GILERA

YL 150

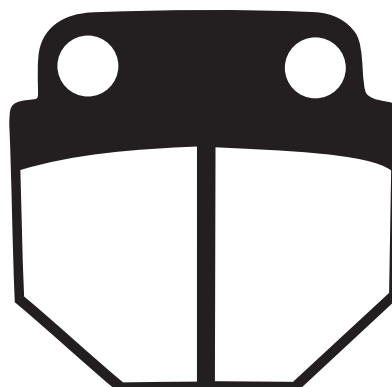

0-505

86x43x7mm

HONDA

Biz
Elite



0-506

109,7x51,3x8,3mm

95,5x37,3x8mm

YAMAHA

YBR 125 (2012)	I	F
New Crypton (2011)	I	F



0-507

45,5x54,5x6,7mm

BAJAJ

Pulsar 220 (Trasera)	I	-
Rouser 220 (Trasera)	I	R



0-508

70x41.2x8mm

MOTOMEL

X 3 M



0-509

73.2x47x7mm

94x47x7mm

ARTIC CAT

DVX 250 | 06-07 | F

BOMBARDIER

DS 250 | 06 | F & R

CANAM

DS 250 | 07 | F & R

KYMCO

Urban 250 | - | -

KRX 250 | - | -

KXR 250 | 04-07 | F

MXU 250 | 04-07 | F

ZANELLA

RZ 200 / 250 | - | Trasera

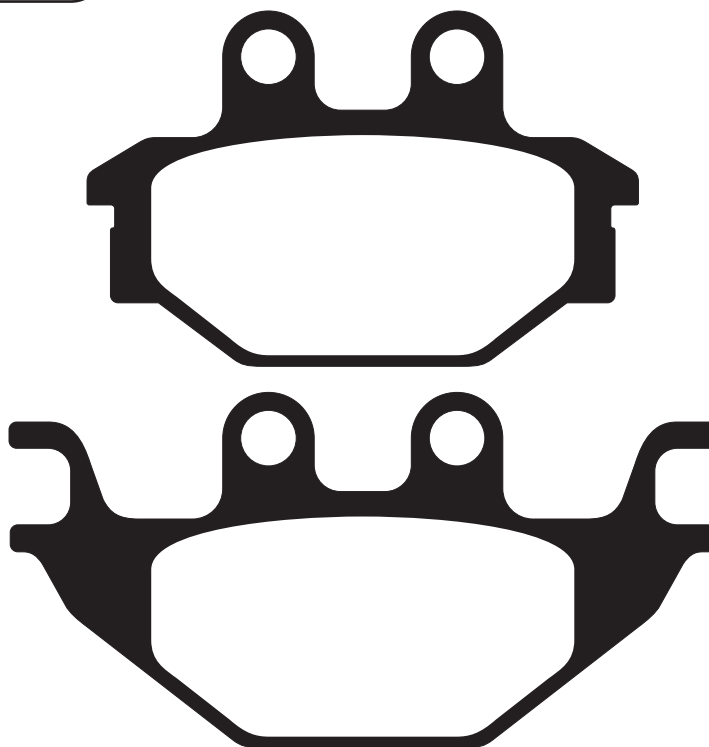

INDICE

O-1 / FA 12	Pág. 03
O-2 / FA 13	Pág. 03
O-4 / FA 11	Pág. 03
O-5/30 / FA 29/30/31	Pág. 04
O-6 / FA 32	Pág. 04
O-7/132 / FA 33	Pág. 04
O-8 / FA 36	Pág. 05
O-9 / FA 35	Pág. 05
O-10 / FA 34	Pág. 05
O-12 / FA 37	Pág. 06
O-14 / FA 61	Pág. 06
O-16	Pág. 06
O-17 / FA 65	Pág. 07
O-18 / FA 68	Pág. 07
O-19/130 / FA 69	Pág. 07
O-19/130 / FA 69	Pág. 08
O-20 / FA 45	Pág. 08
O-21 / FA 51	Pág. 08
O-22	Pág. 09
O-23	Pág. 09
O-24 / FA 38	Pág. 09
O-27 / FA 40	Pág. 10
O-28 / FA 18	Pág. 10
O-31 / FA 47/47-2/47-3	Pág. 11
O-32 / FA 67/67-2/67-3	Pág. 12
O-33 / FA 129	Pág. 13
O-34 / FA 131	Pág. 14
O-35 / FA 140	Pág. 14
O-36 / FA 142/196	Pág. 15
O-37 / FA 130	Pág. 15
O-38 / FA 160	Pág. 16
O-39 / FA 88	Pág. 16
O-40 / FA 101	Pág. 16
O-41 / FA 141	Pág. 17
O-42 / FA 85	Pág. 17
O-43 / FA 169	Pág. 18
O-44 / FA 54/178	Pág. 18
O-45	Pág. 19
O-46	Pág. 19
O-47/140 / FA 143/185	Pág. 19
O-47/140 / FA 143/185	Pág. 20
O-48 / FA 145	Pág. 20
O-49 / FA 83	Pág. 21
O-50 / FA 152	Pág. 21
O-51 / FA 124/124-2	Pág. 22
O-52	Pág. 22
O-53 / FA 202	Pág. 22
O-54	Pág. 23
O-55	Pág. 23
O-56	Pág. 23
O-57 / FA 63	Pág. 23
O-58 / FA 165	Pág. 24
O-59 / FA 104	Pág. 24
O-60 / FA 103	Pág. 24
O-61	Pág. 25
O-62 / FA 158	Pág. 25
O-63 / FA 121	Pág. 25
O-64	Pág. 26
O-65 / FA 157	Pág. 26
O-66 / FA 81	Pág. 26
O-67 / FA 174	Pág. 27
O-68	Pág. 27
O-69 / FA 92	Pág. 27
O-70 / FA 125	Pág. 28
O-71 / FA 147	Pág. 28
O-72	Pág. 28
O-73	Pág. 29
O-75/142 / FA 84	Pág. 29
O-77 / FA 172	Pág. 30

O-78 / FA 80-2	Pág. 30
O-80	Pág. 30
O-81 / FA 193	Pág. 31
O-83 / FA 90	Pág. 31
O-85 / FA 70	Pág. 31
O-86/87 / FA 192	Pág. 32
O-89/136 / FA 188	Pág. 32
O-90 / FA 189	Pág. 32
O-91 / FA 106/106-2	Pág. 33
O-92 / FA 105	Pág. 33
O-95	Pág. 33
O-96 / FA 86	Pág. 34
O-97/197 / FA 197	Pág. 34
O-98 / FA 115	Pág. 35
O-99 / FA 275	Pág. 35
O-100 / FA 208	Pág. 36
O-102	Pág. 36
O-104	Pág. 37
O-105 / FA 159	Pág. 37
O-106	Pág. 37
O-107 / FA 199	Pág. 38
O-108 / FA 60	Pág. 38
O-109 / FA 232	Pág. 39
O-110 / FA 270R	Pág. 39
O-111	Pág. 39
O-114 / FA 155	Pág. 39
O-116	Pág. 40
O-117 / FA 119	Pág. 40
O-119 / FA 194	Pág. 40
O-120	Pág. 41
O-121 / FA 231/259	Pág. 41
O-122 / FA 229	Pág. 41
O-122 / FA 229	Pág. 42
O-123	Pág. 42
O-124	Pág. 42
O-125	Pág. 42
O-126 / FA 323-3	Pág. 43
O-128 / FA 41	Pág. 43
O-133 / FA 265HH/296	Pág. 43
O-134 / FA 261HH	Pág. 44
O-135 / FA 136	Pág. 44
O-137 / FA 351	Pág. 44
O-138 / FA 367X	Pág. 45
O-139 / FA 209/209-2	Pág. 45
O-141 / FA 132	Pág. 45
O-150 / FA 150	Pág. 46
O-161 / FA 161	Pág. 46
O-170 / FA 170	Pág. 46
O-171 / FA 171	Pág. 46
O-181 / FA 181	Pág. 47
O-182 / FA 182	Pág. 47
O-187 / FA 187	Pág. 47
O-187 / FA 187	Pág. 48
O-196 / FA 196	Pág. 48
O-200 / FA 200	Pág. 49
O-203 / FA 203	Pág. 49
O-213 / FA 213	Pág. 49
O-213 / FA 213	Pág. 50
O-214 / FA 214/214-2	Pág. 51
O-215 / FA 215/215-2	Pág. 51
O-226 / FA 226	Pág. 52
O-230 / FA 130	Pág. 52
O-233 / FA 233	Pág. 52
O-235/228 / FA 135	Pág. 53
O-236 / FA 236	Pág. 53
O-237 / FA 137	Pág. 54
O-240 / FA 40	Pág. 54
O-244 / FA 244	Pág. 54
O-244 / FA 244	Pág. 55

O-245 / FA 245	Pág. 55
O-246 / FA 146	Pág. 55
O-249 / FA 249/249-2	Pág. 56
O-260 / FA 260	Pág. 56
O-281 / FA 281	Pág. 56
O-294 / FA 294HH	Pág. 57
O-296 / FA 296HH	Pág. 57
O-298 / FA 298	Pág. 57
O-298 / FA 298	Pág. 58
O-299 / FA 299	Pág. 58
O-301 / FA 251	Pág. 59
O-302 / FA 252	Pág. 59
O-303 / FA 254	Pág. 59
O-304 / FA 257-2	Pág. 60
O-305 / FA 267	Pág. 60
O-307 / FA 307	Pág. 60
O-308 / FA 366	Pág. 61
O-309 / FA 372R	Pág. 61
O-310 / FA 94	Pág. 61
O-311 / FA 95/95-2	Pág. 62
O-312 / FA 123	Pág. 62
O-314 / FA 314R	Pág. 63
O-317 / FA 317X	Pág. 63
O-319 / FA 319	Pág. 63
O-335 / FA 335HH	Pág. 64
O-342 / FA 342SV	Pág. 64
O-344 / FA 344X	Pág. 65
O-346 / FA 346X	Pág. 65
O-349 / FA 349R	Pág. 65
O-363 / FA 245	Pág. 66
O-367 / FA 367X	Pág. 66
O-368 / FA 368	Pág. 66
O-369 / FA 369-4HH	Pág. 66
O-376 / FA 376	Pág. 67
O-379 / FA 379HH	Pág. 67
O-380 / FA 380HH	Pág. 67
O-381 / FA 381	Pág. 68
O-387 / FA 387	Pág. 68
O-387 / FA 387	Pág. 69
O-390 / FA 380HH	Pág. 69
O-400 / FA 400	Pág. 70
O-401 / FA 401	Pág. 70
O-407 / FA 407	Pág. 71
O-408 / FA 408	Pág. 71
O-411 / FA 411	Pág. 71
O-412 / FA 412	Pág. 72
O-413 / FA 413X	Pág. 72
O-414 / FA 414X	Pág. 72
O-417 / FA 417-4HH	Pág. 73
O-424 / FA 424	Pág. 73
O-428 / FA 428	Pág. 73
O-434 / FA 434	Pág. 74
O-436 / FA 436	Pág. 74
O-441 / FA 441HH	Pág. 75
O-465 / FA 465TT	Pág. 75
O-500	Pág. 76
O-501	Pág. 76
O-502	Pág. 77
O-503	Pág. 77
O-504	Pág. 77
O-505	Pág. 78
O-506	Pág. 78
O-507	Pág. 78
O-508	Pág. 79
O-509	Pág. 79

CONSULTAS

www.imexares.com.ar

ventas@imexares.com.ar



A series of 20 horizontal gray lines providing a template for writing text.

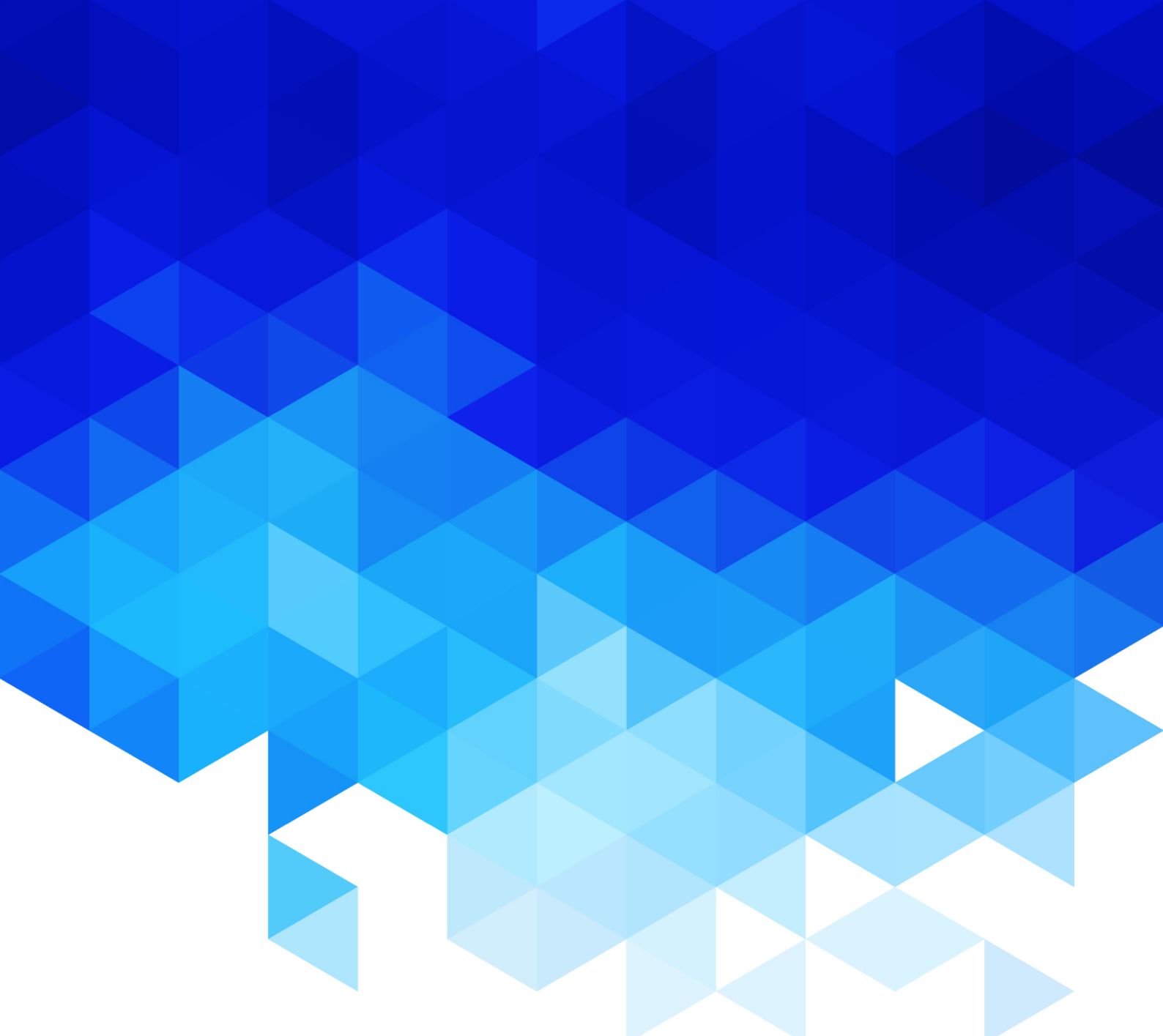

ORA ES OTRO PRODUCTO DE

imeXares®

PRODUCTO  ARGENTINO

www.imexares.com.ar / ventas@imexares.com.ar